

Villy 34 3x3

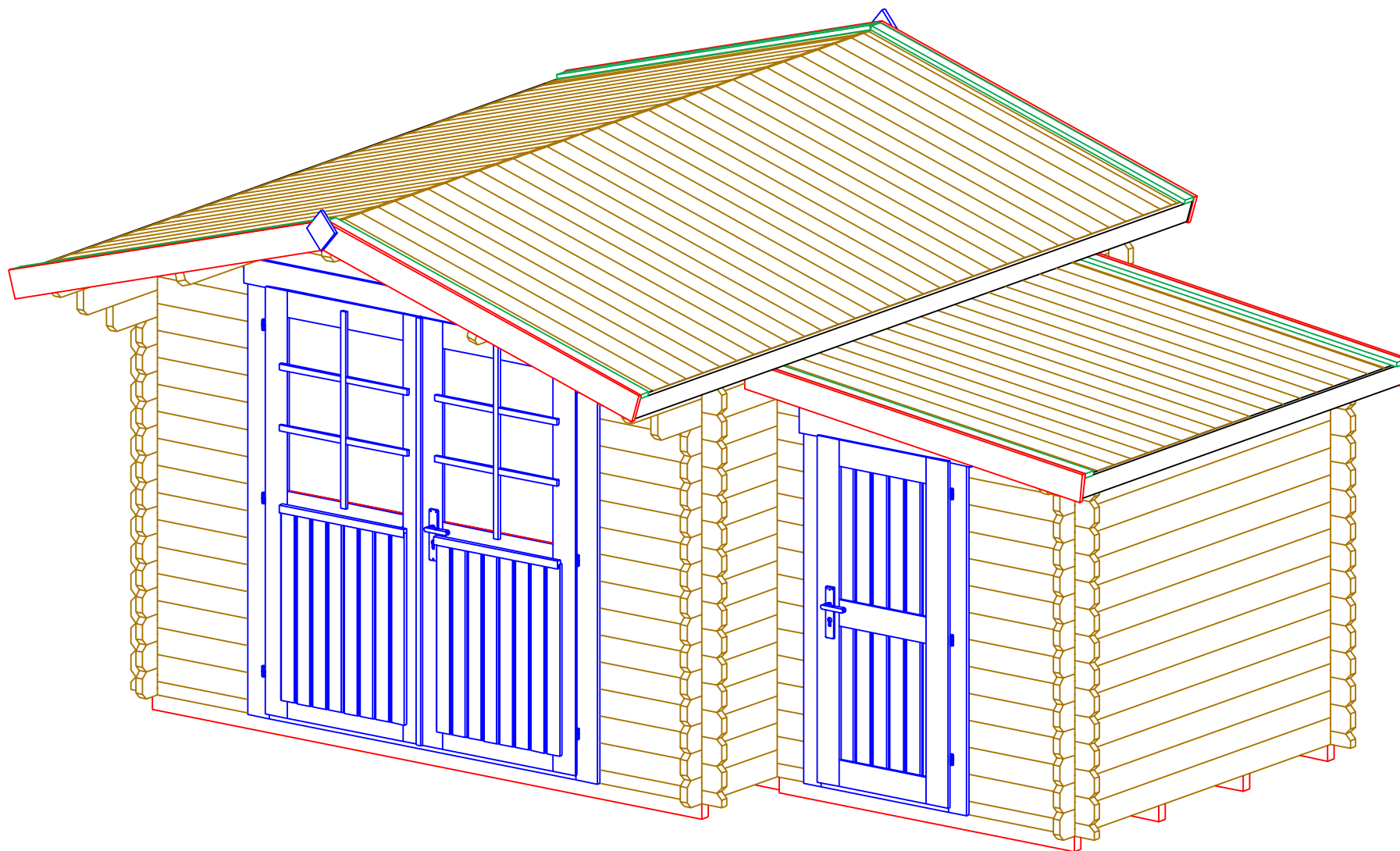

Villy 34 3x3

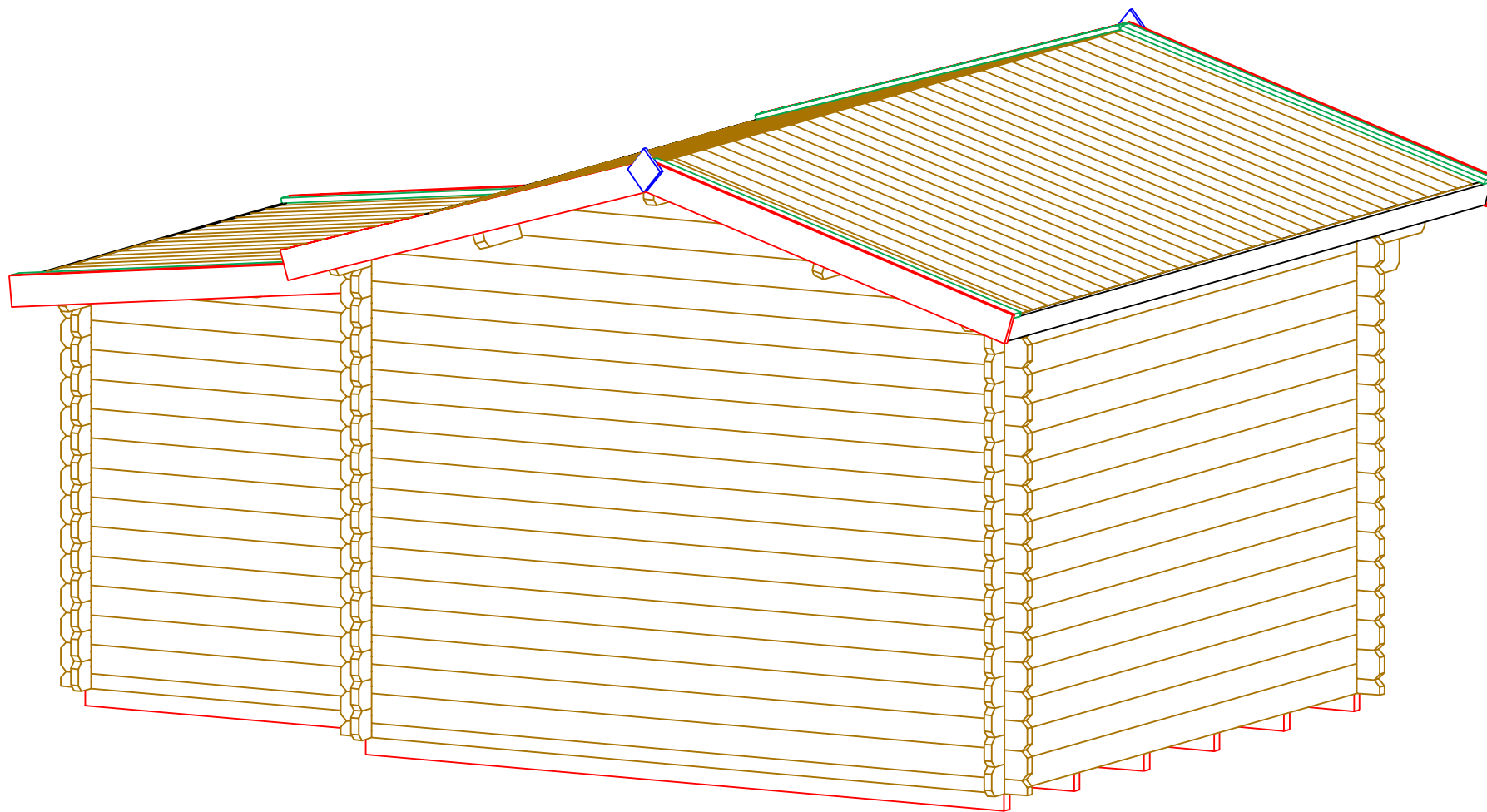

Villy 34 3x3

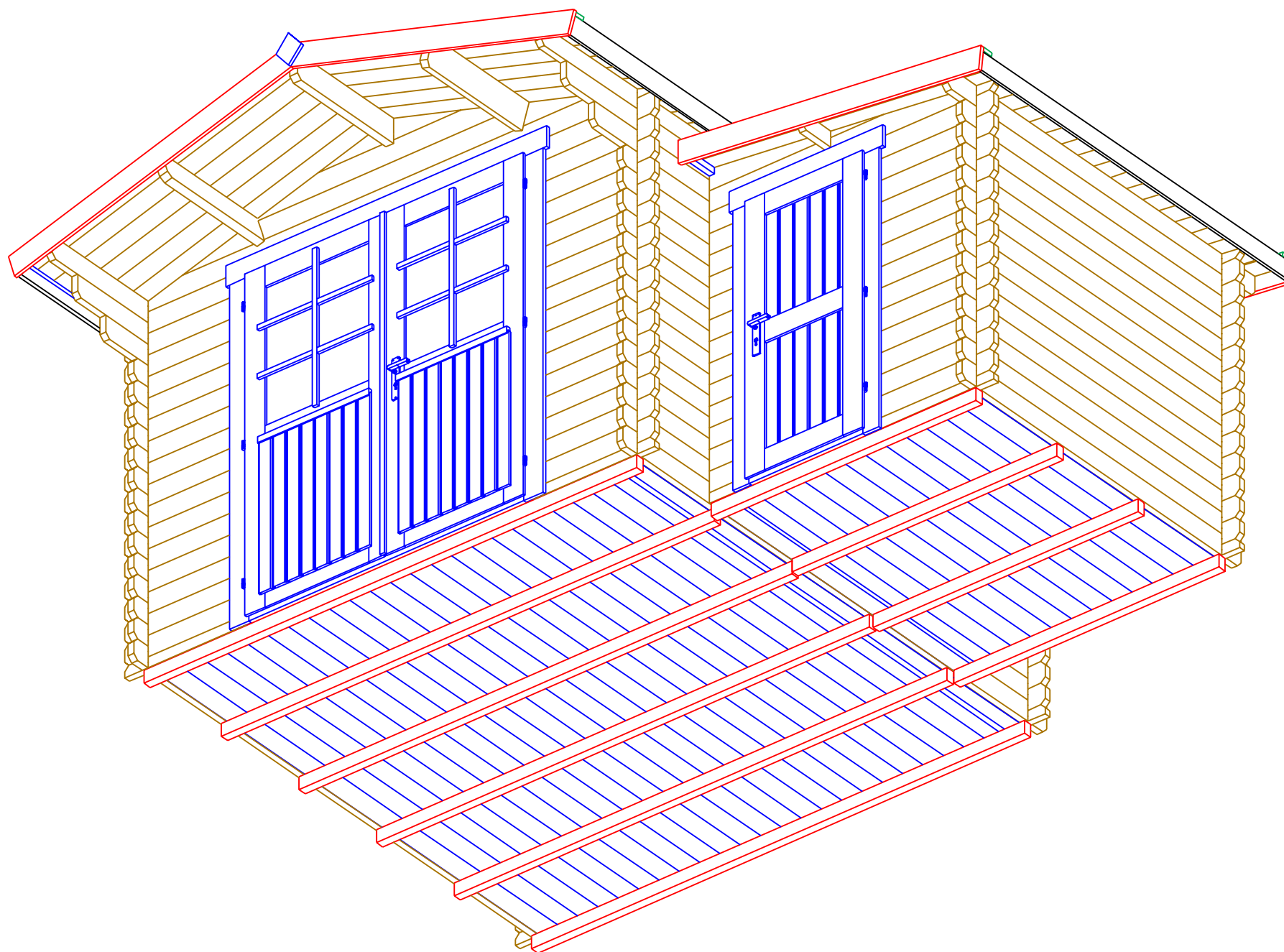

Villy 34 3x3
Plan

Стена B
Wand B
Wall B
Mur B

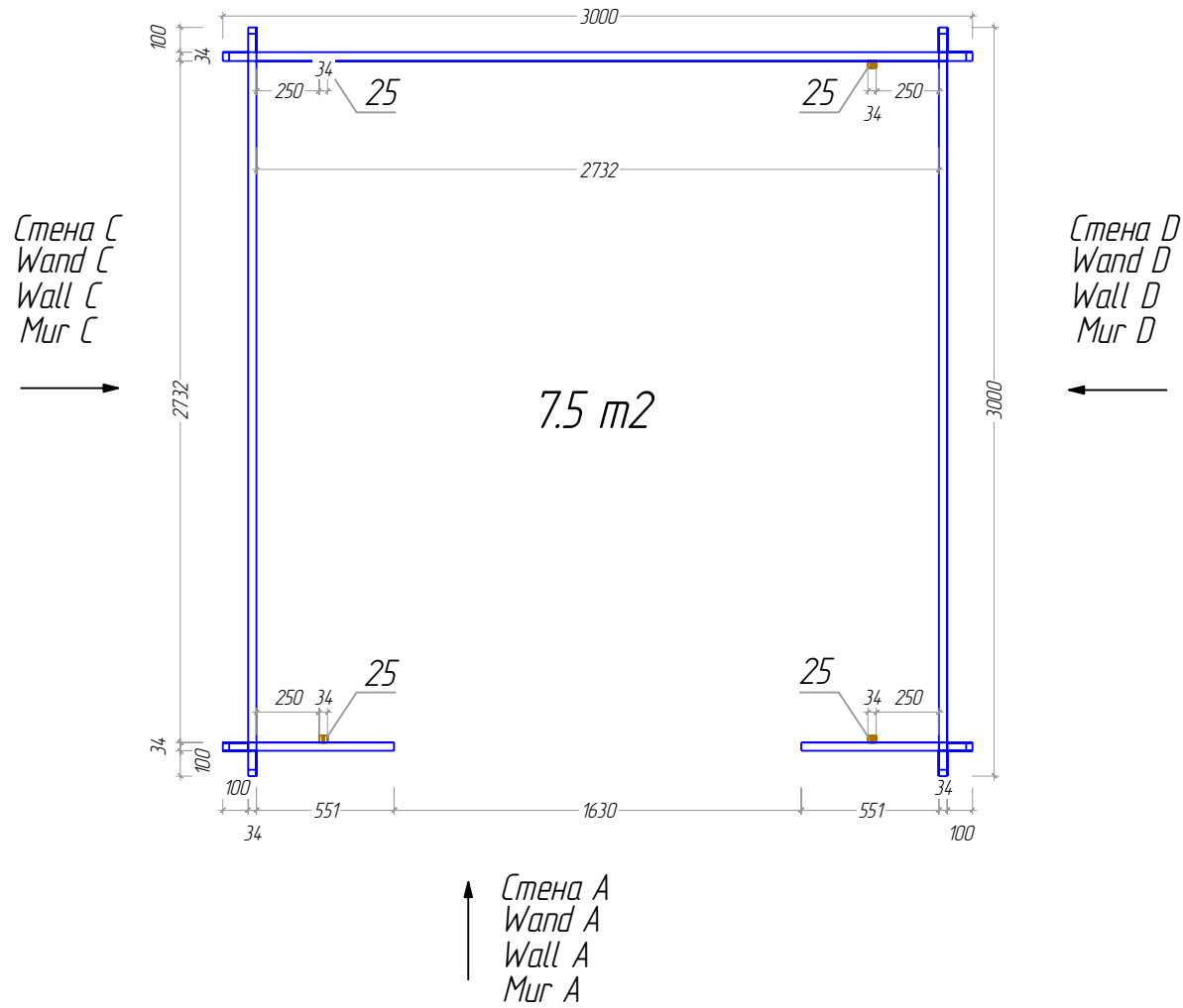

Villy 34 3x3

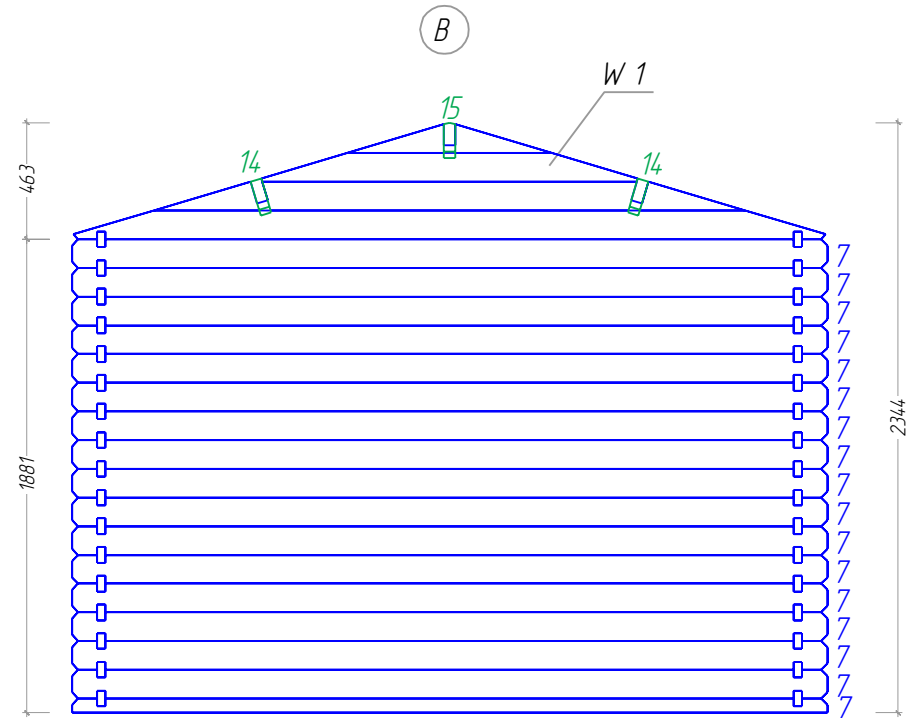
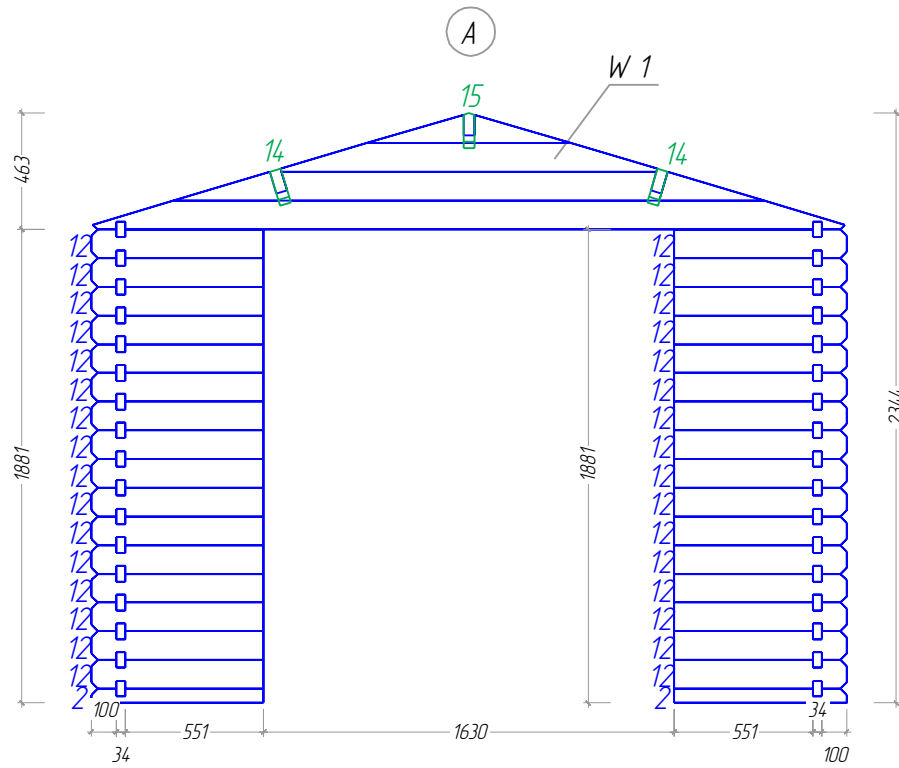

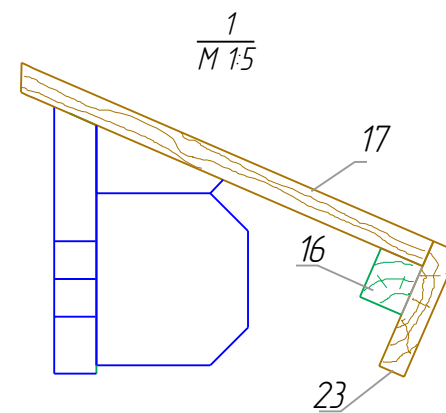
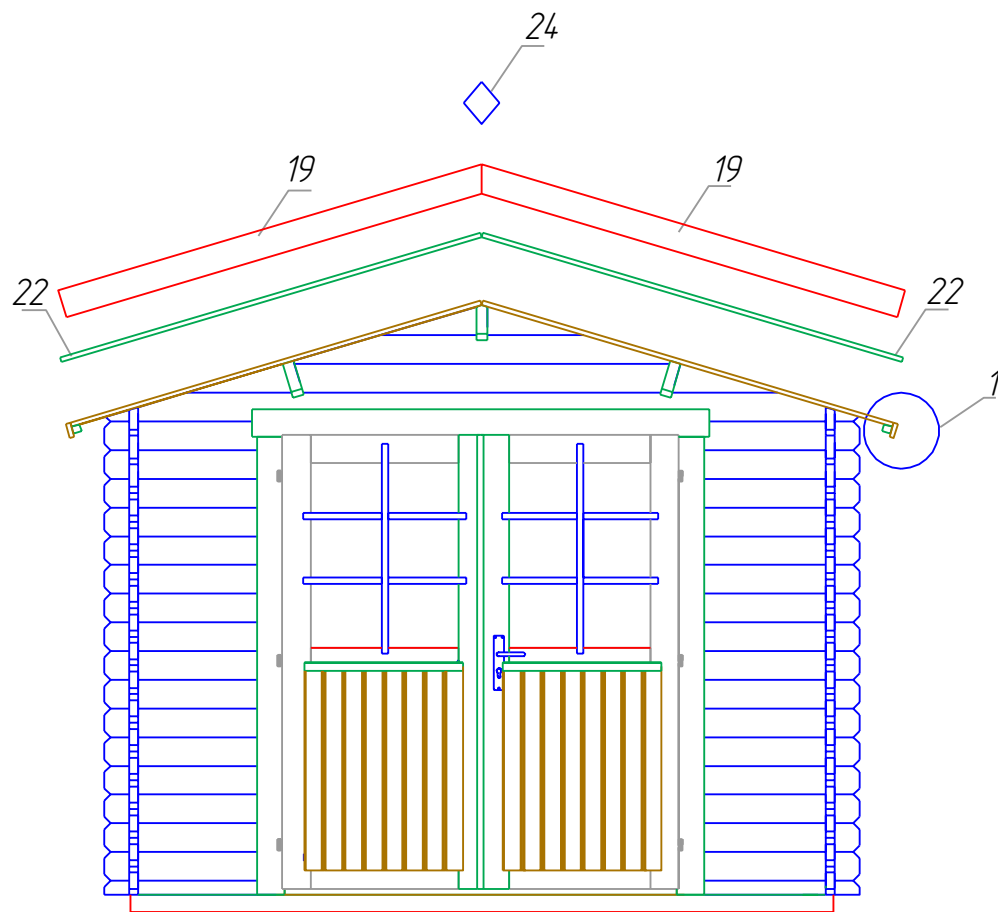

Villy 34 3x3

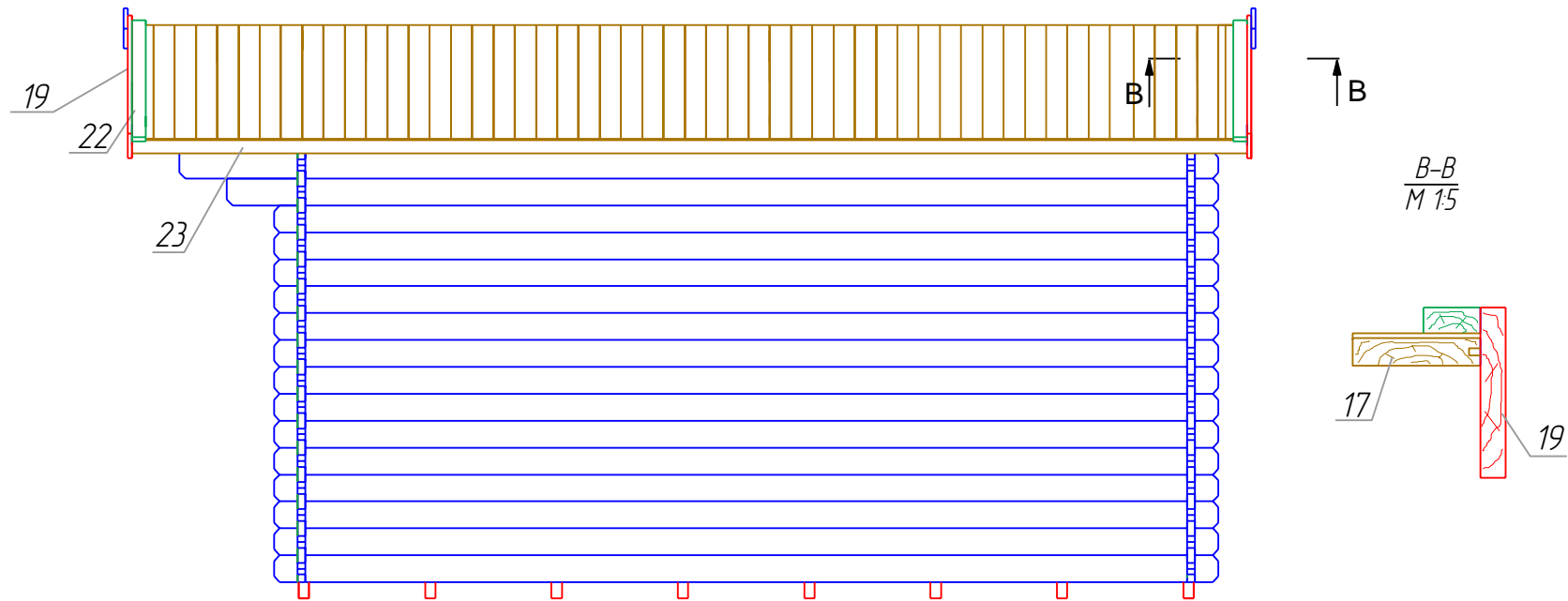

Villy 34 3x3

Boarding joist plan

Trummplan

Lambourde plan

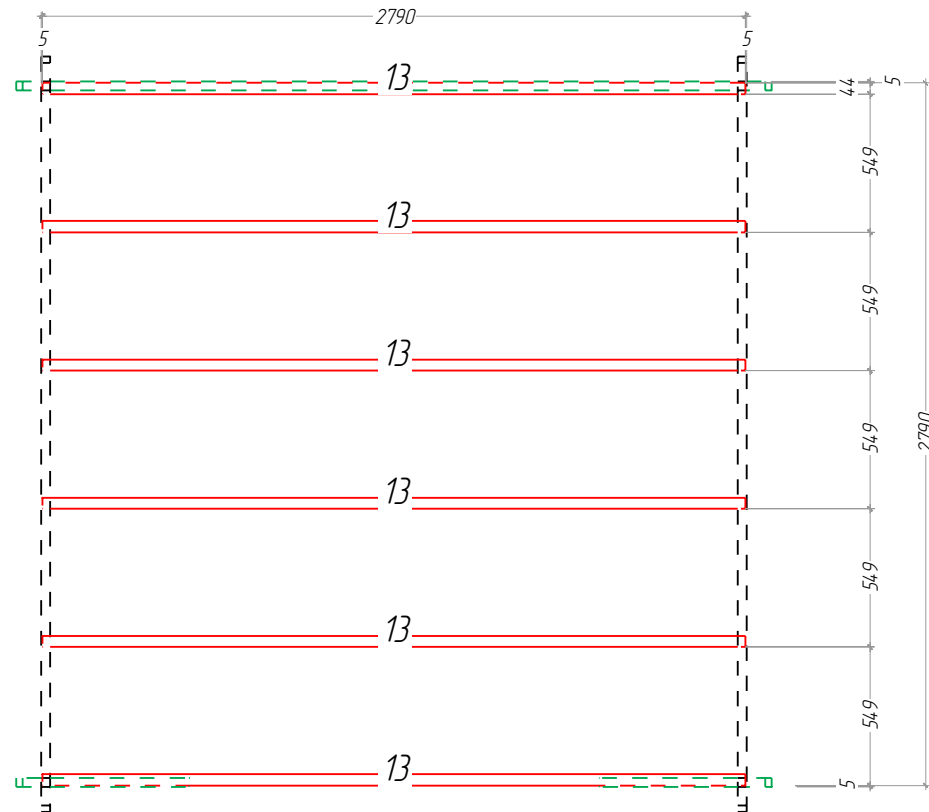





Villy 34 3x3



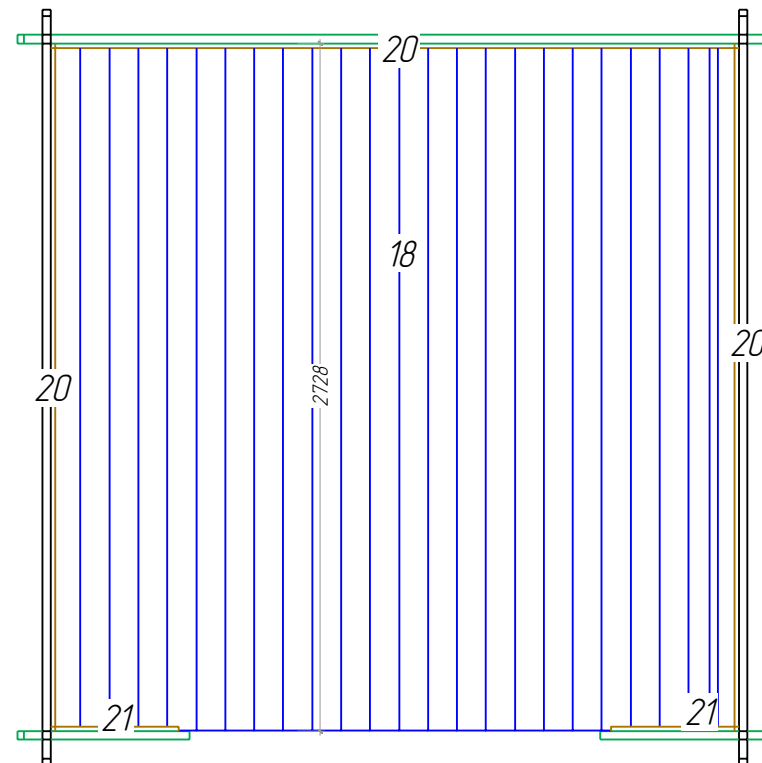

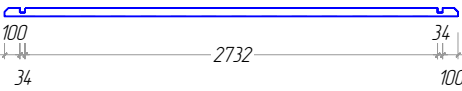
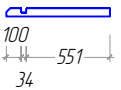
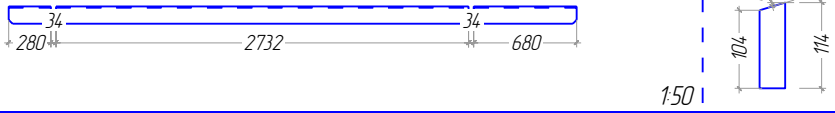
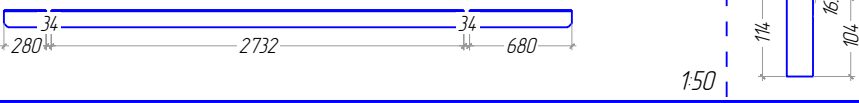
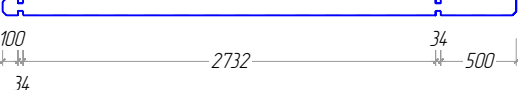
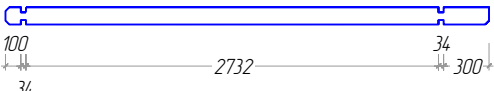
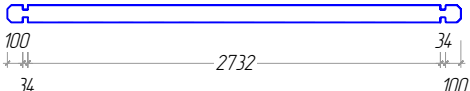
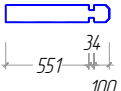
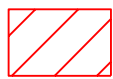

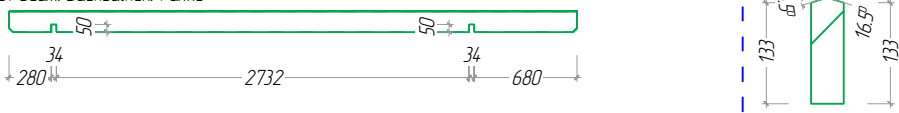
Plan of the floor board

Plan der Furbodenbretter

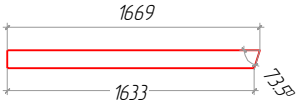
Le plan des plaches du plancher

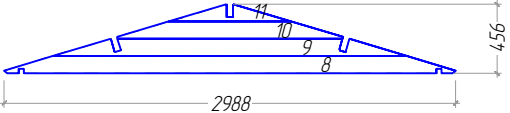

Nº	Villy 34 3x3	Nr.	Profile (mm)	Lenght (mm)
1		1	34x57	3000mm
2		2	34x57	685mm
3		1	34x114	3760mm
4		1	34x114	3760mm
5		2	34x114	3400mm
6		2	34x114	3200mm
7		44+1	34x114	3000mm
12		32	34x114	685mm
13	<p>Foundation Fundament Solve</p> 	6	44x68	2790mm
14	<p>Roof beam. Dachbalken. Panne</p> 	2	44x140	3760mm
15	<p>Roof beam. Dachbalken. Panne</p> 	1	44x140	3760mm
16	<p>Roof edge reinforcement Traufenleiste Tasseau</p> 	4	28x34	1880mm
17	<p>Roof boards. Dachbretter Volige</p> 	66+1	20x115	1634mm

N°	Villy 34 3x3	Nr.	Profile (mm)	Lenght (mm)
18	Floor boards Fu ssboden Lame de plancher 	24+1	20x115	2728mm
19	Fascia board Giebelblende Planch de rive facade 	4	18x120	1669mm
20	Floor edge trim Fu bleisten Plinthe plancher 	3	18x20	2732mm
21	Floor edge trim Fu bleisten Plinthe plancher 	2	18x20	508mm
22	Roofing felt fillet Giebelabschlussbrett Latte de finition couverture 	4	18x58	1659mm
23	Roof side boards Traufenbrett Planche de rive 	2	18x95	3760mm
24	Diamond Raufe Diamant 	2	T. 18	120mm
25	Storm protection 	4	28x34	1900mm
W-1		2		
	Door Tur La porte 1881MMX1630MM	1		

W-1

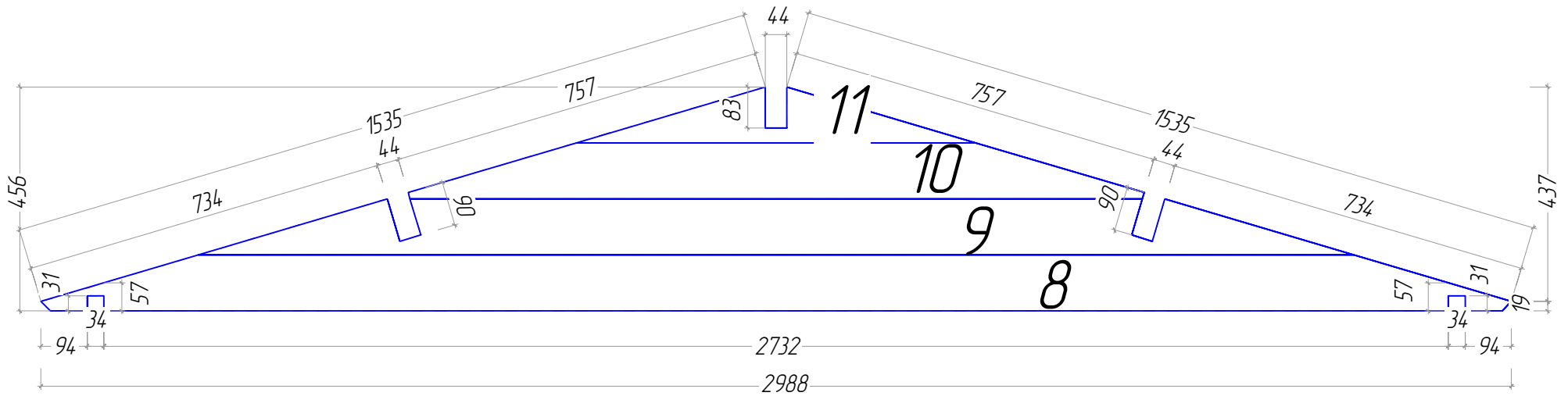

Villy 34 3x3
Storm protection

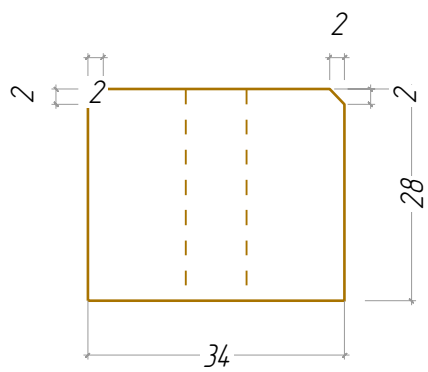
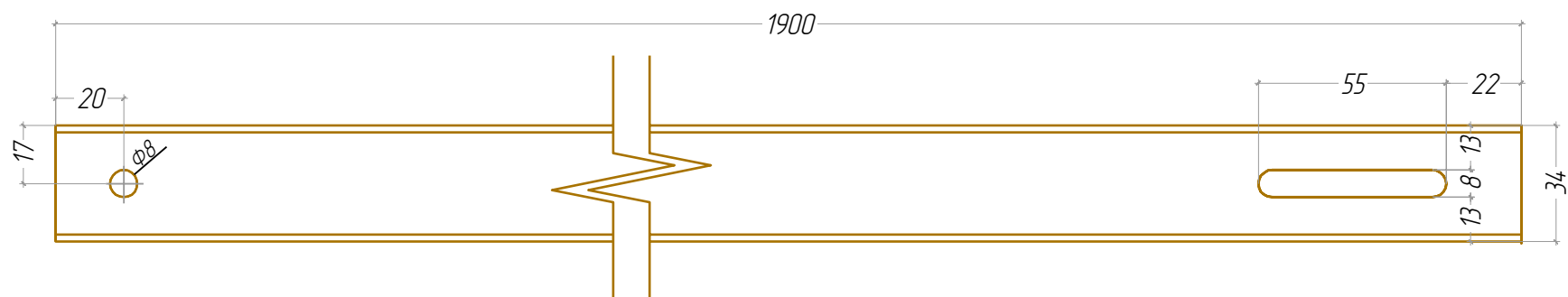

Villy 34 3x3 (πυροπροστασία)

Grundriss

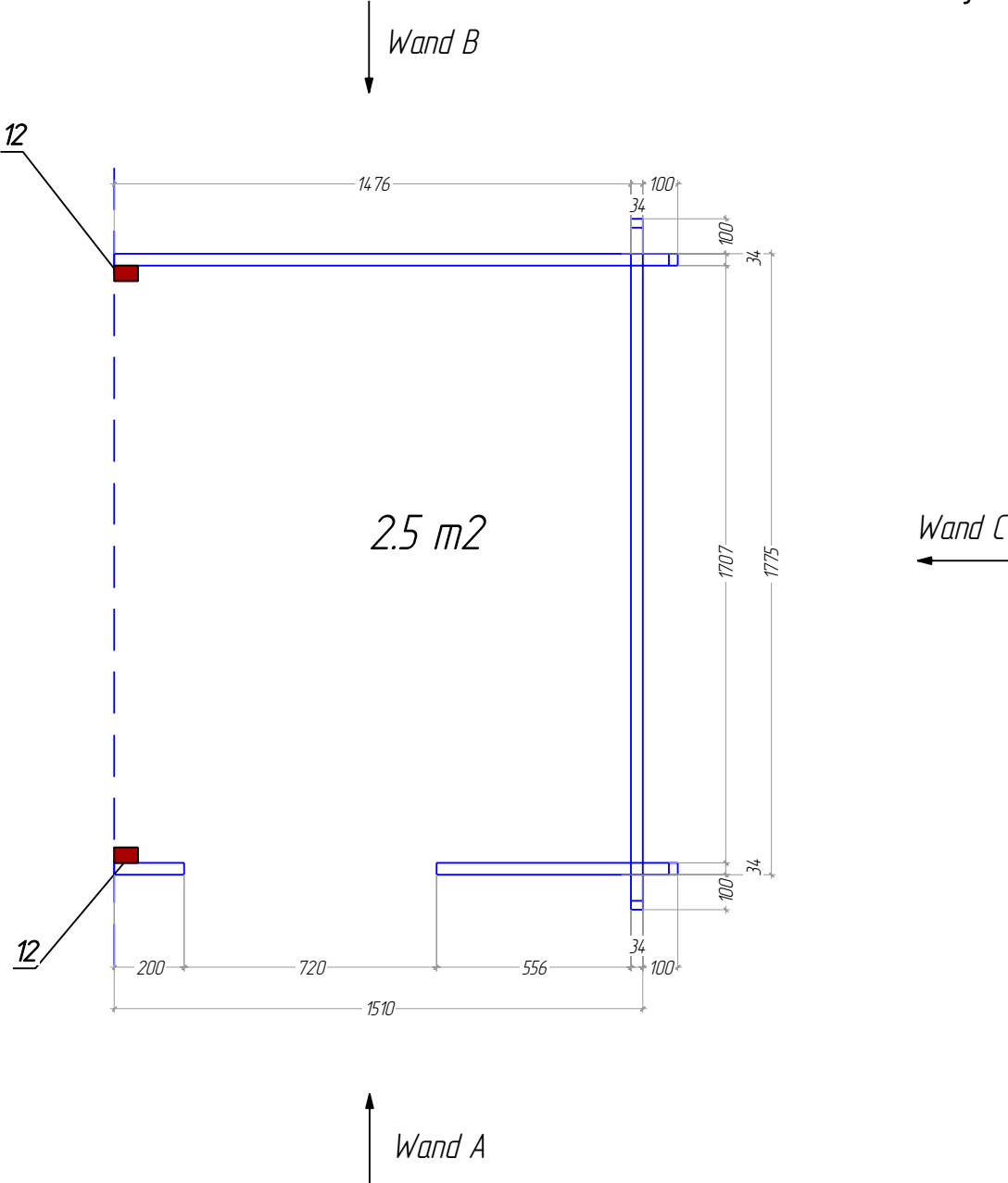

Villy 34 3x3 (приспособка)

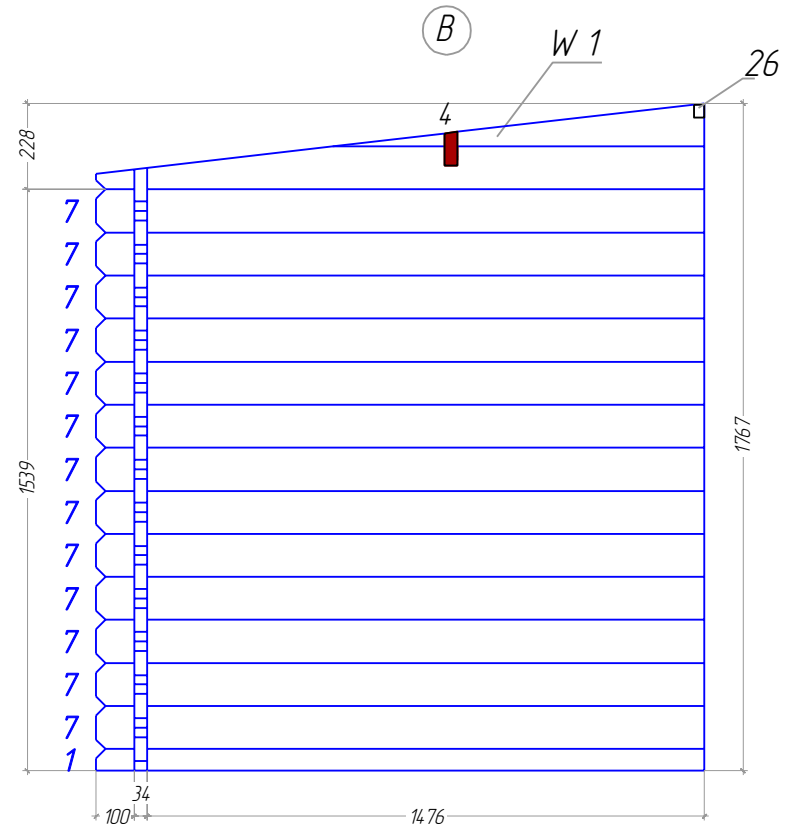
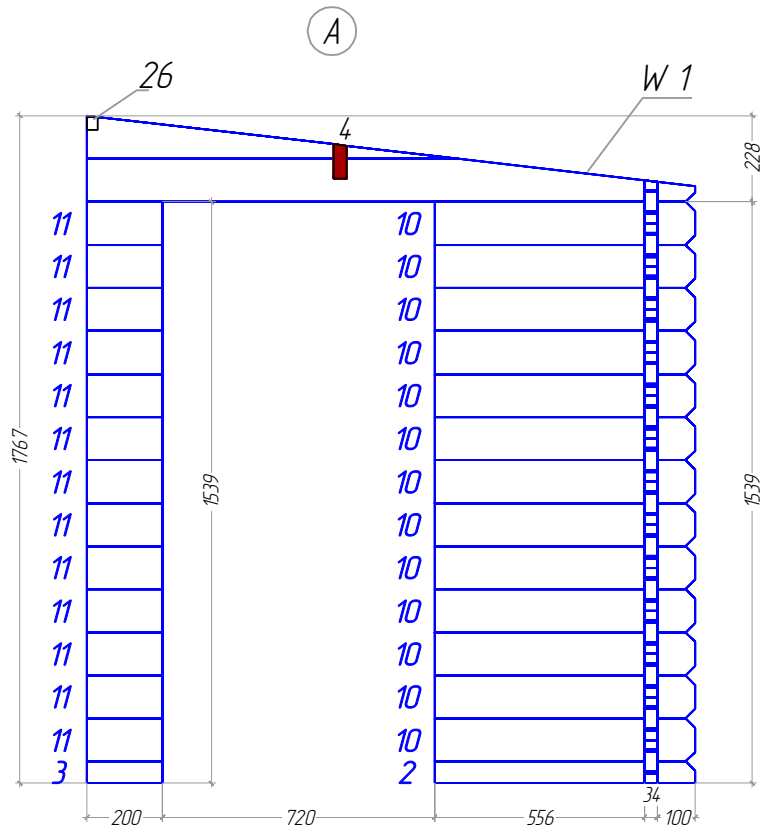

Villy 34 3x3 (ηρυστρωῦκα)

Ⓢ

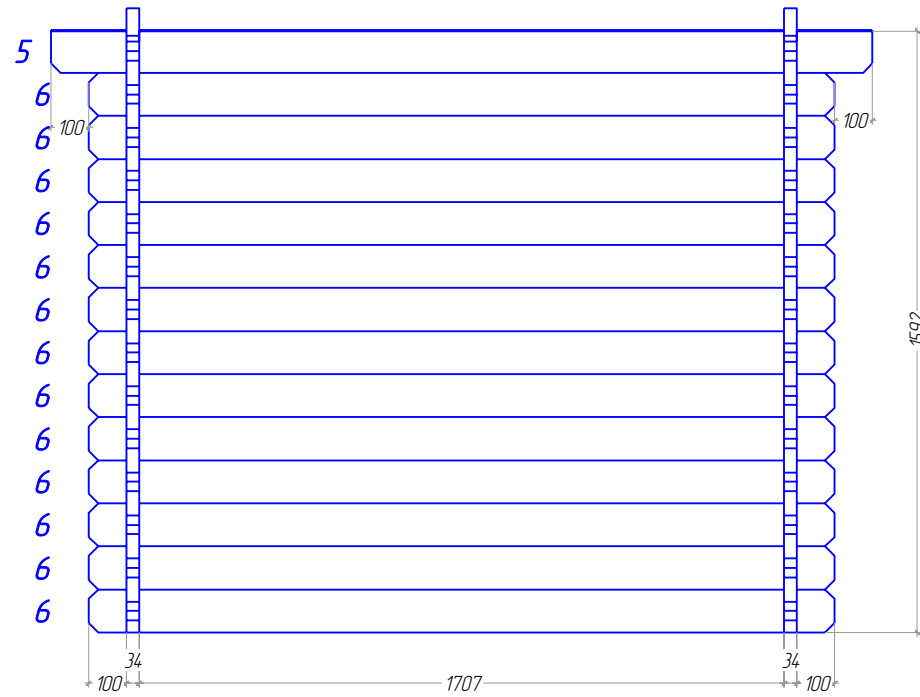

Villy 34 3x3 (приспособка)

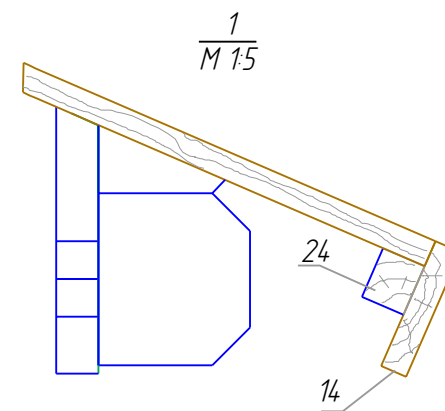
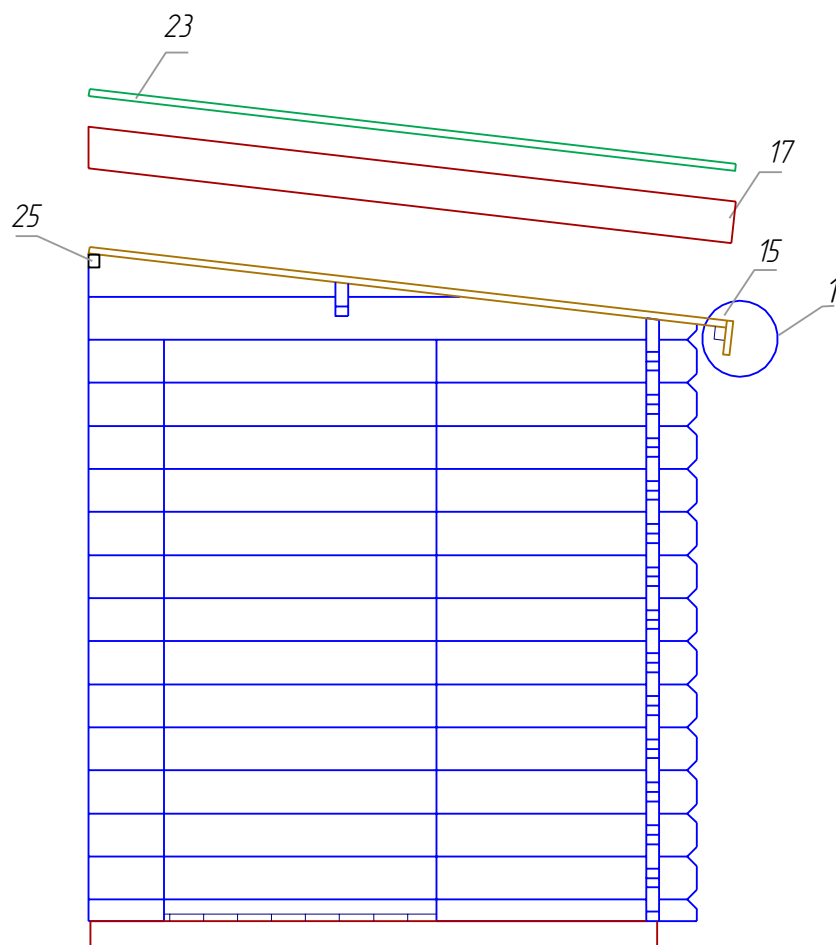

Villy 34 3x3 (приспособка)

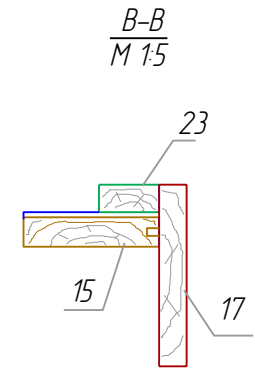
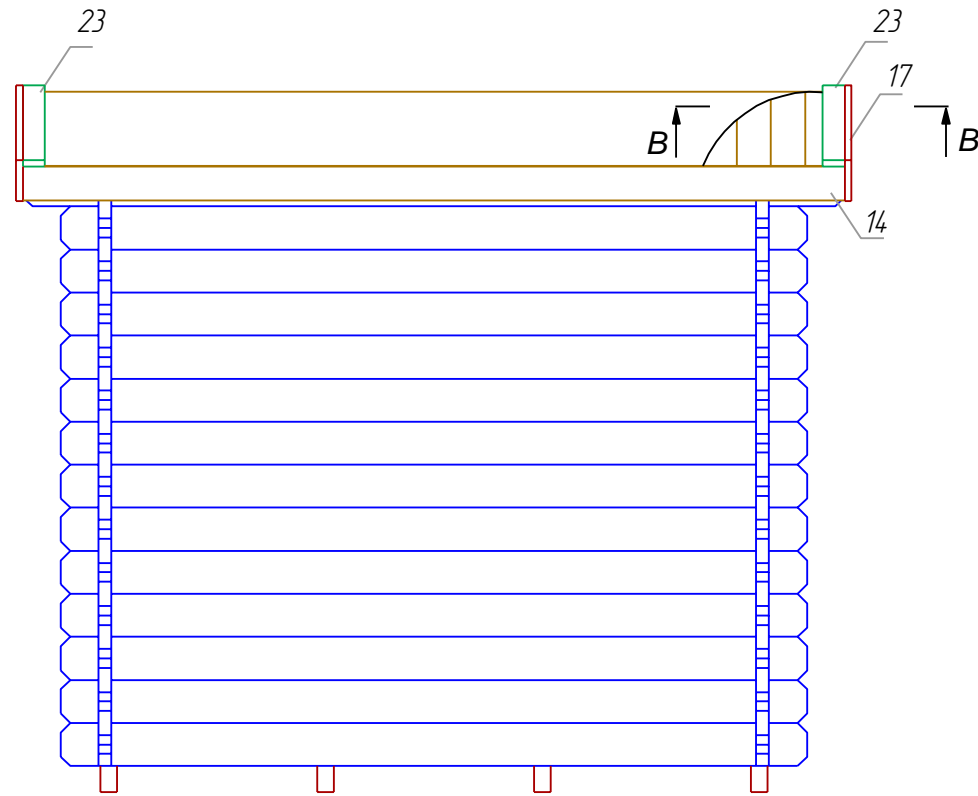





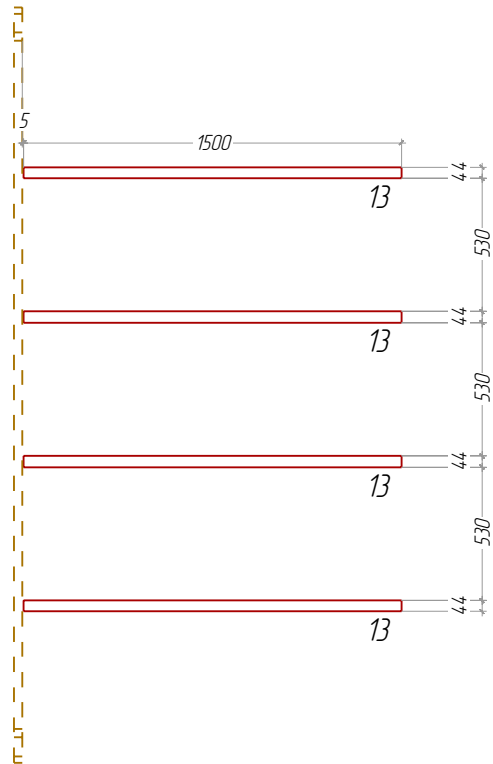

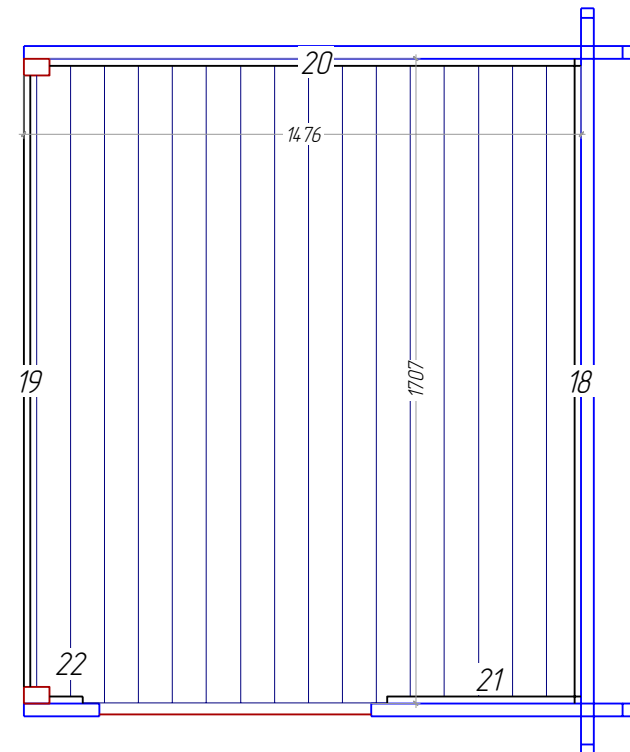

Villy 34 3x3 (приспособка)

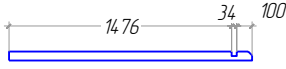
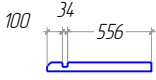

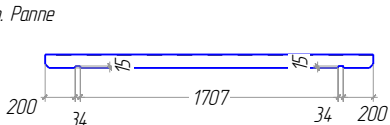
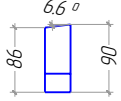
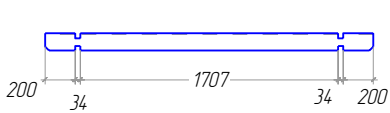
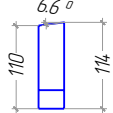
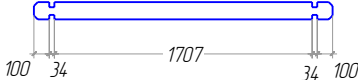
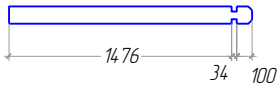
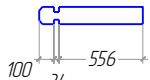



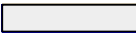

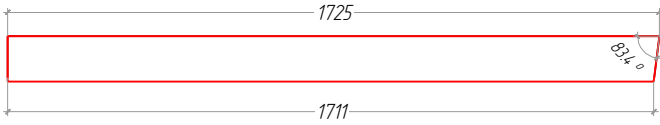

Fundament balken



Fussboden

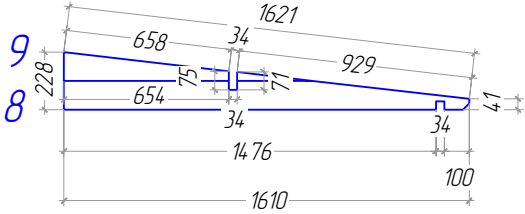

№	Villy 34 3x3 (ηρυστρούκα)	St.	Schnittl	Länge
1		1	34x57	1610mm
2		1	34x57	690mm
3		1	34x57	200mm
4	<p data-bbox="239 672 470 694"><i>Roof beam, Dachbalken, Panne</i></p>  	1	34x90	2175mm
5	 	1	34x114	2175mm
6		13+1	34x114	1975mm
7		13	34x114	1610mm
10		13	34x114	690mm
11		13	34x114	200mm
12		2	44x68	1709mm
13	<p data-bbox="263 1713 359 1780"><i>Foundation Fundament Solvie</i></p> 	4	44x68	1500mm
14	<p data-bbox="263 1848 399 1926"><i>Roof side boards Traufenbrett Planche de rive</i></p> 	1	18x95	2175mm
15	<p data-bbox="263 2004 375 2072"><i>Roof boards Dachbretter Volige</i></p> 	19+1	20x115	1698mm

Nº	Villy 34 3x3 (приспособка)	St.	Schnitt	Länge
16	Floor boards Fu ssboden Lame de plancher 	13+1	20x115	1703mm
17	Fascia board Giebelblende Planch de rive facade 	2	18x120	1725mm
18	Floor edge trim Fu bleisten Plinthe plancher 	1	18x20	1707mm
19	Floor edge trim Fu bleisten Plinthe plancher 	1	18x20	1619mm
20	Floor edge trim Fu bleisten Plinthe plancher 	1	18x20	1408mm
21	Floor edge trim Fu bleisten Plinthe plancher 	1	18x20	513mm
22	Floor edge trim Fu bleisten Plinthe plancher 	1	18x20	89mm
23	Roof edge reinforcement Traufleisten Tasseau 	2	18x58	1723mm
24	Roofing felt fillet Giebelabschlussbrett Latte de finition couverture 	1	28x34	2175mm
25	Roofing felt fillet Giebelabschlussbrett Latte de finition couverture 	1	28x34	1705mm
26	Roofing felt fillet Giebelabschlussbrett Latte de finition couverture 	2	28x34	200mm
W1		2		
	Door Tur La porte 1539x720MM	1		