

Paloma 34 4X4

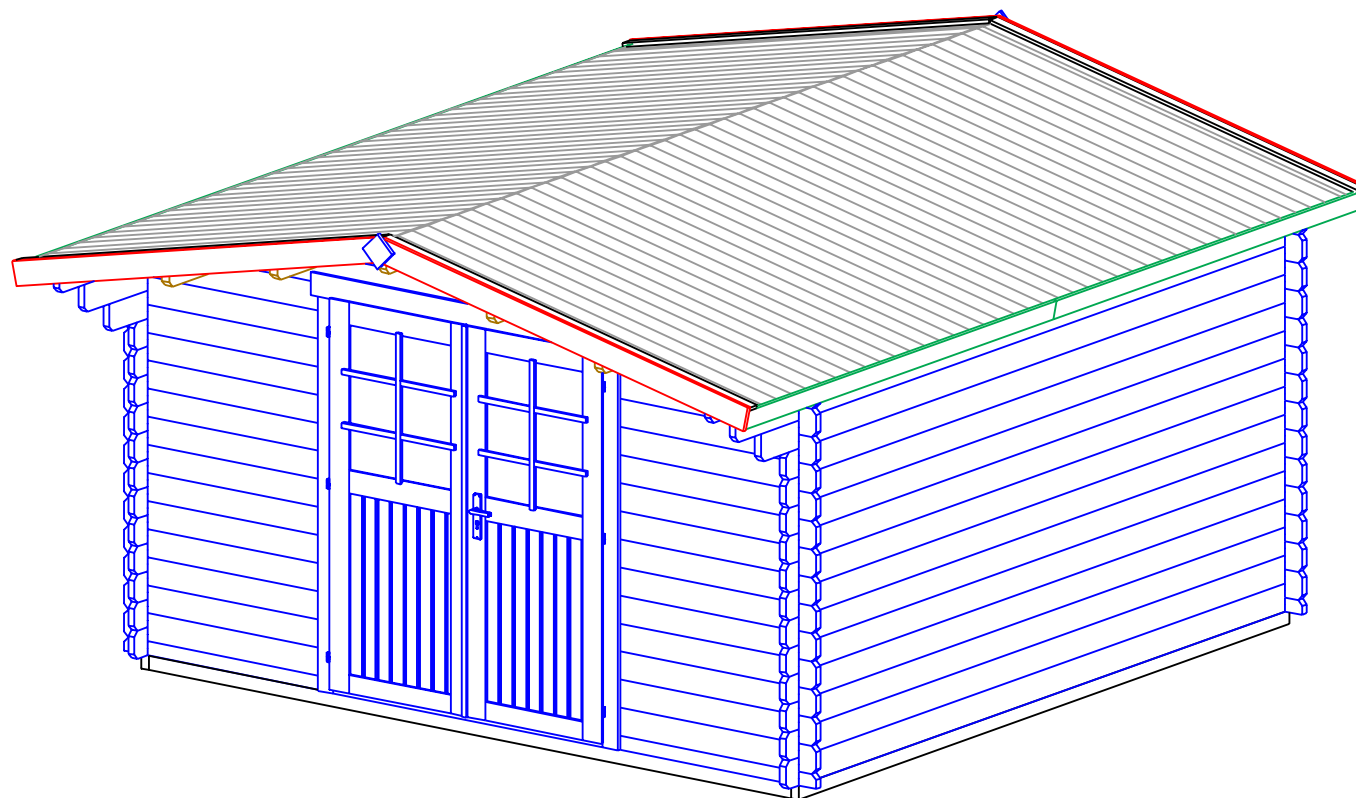

Paloma 34 4X4

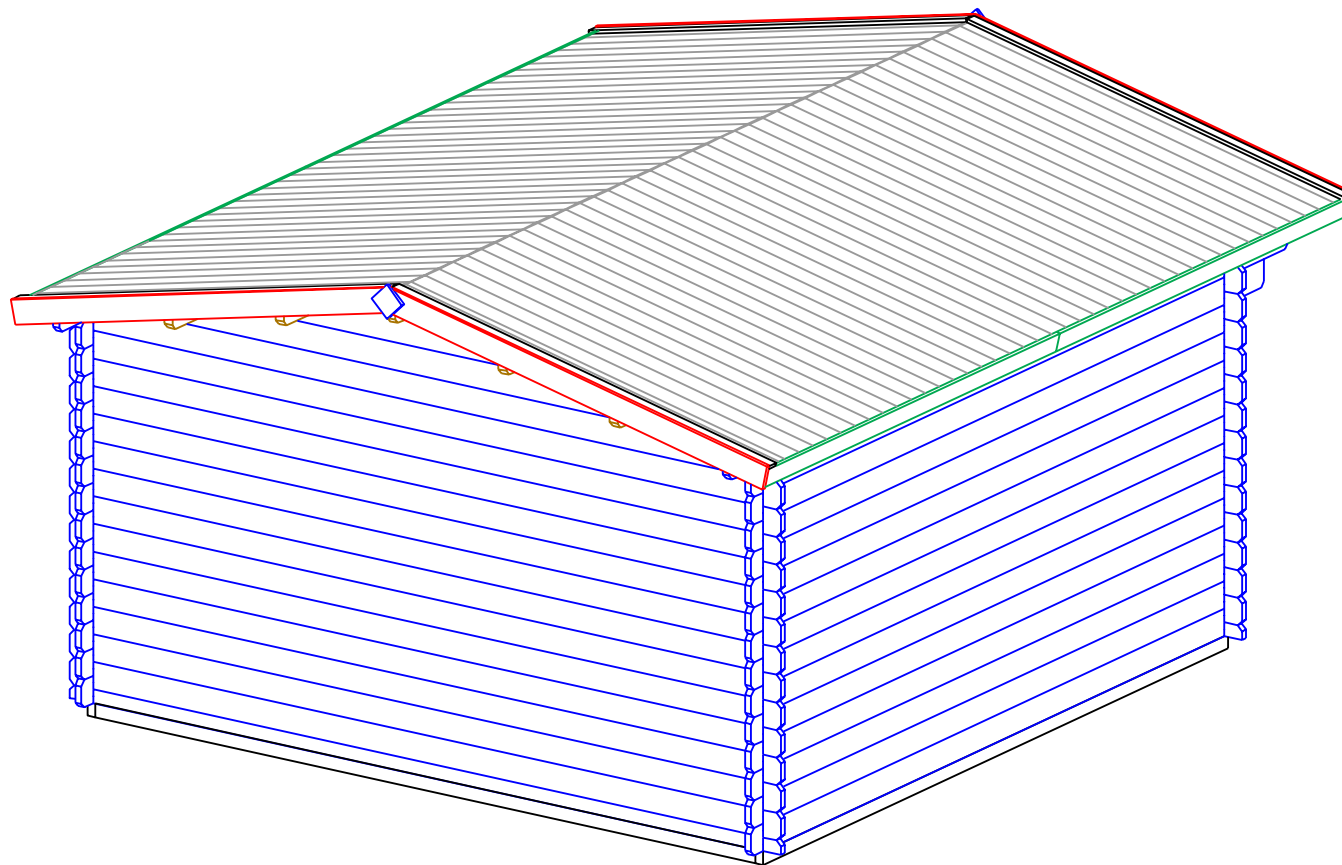

STAGE 1

Paloma 34 4X4

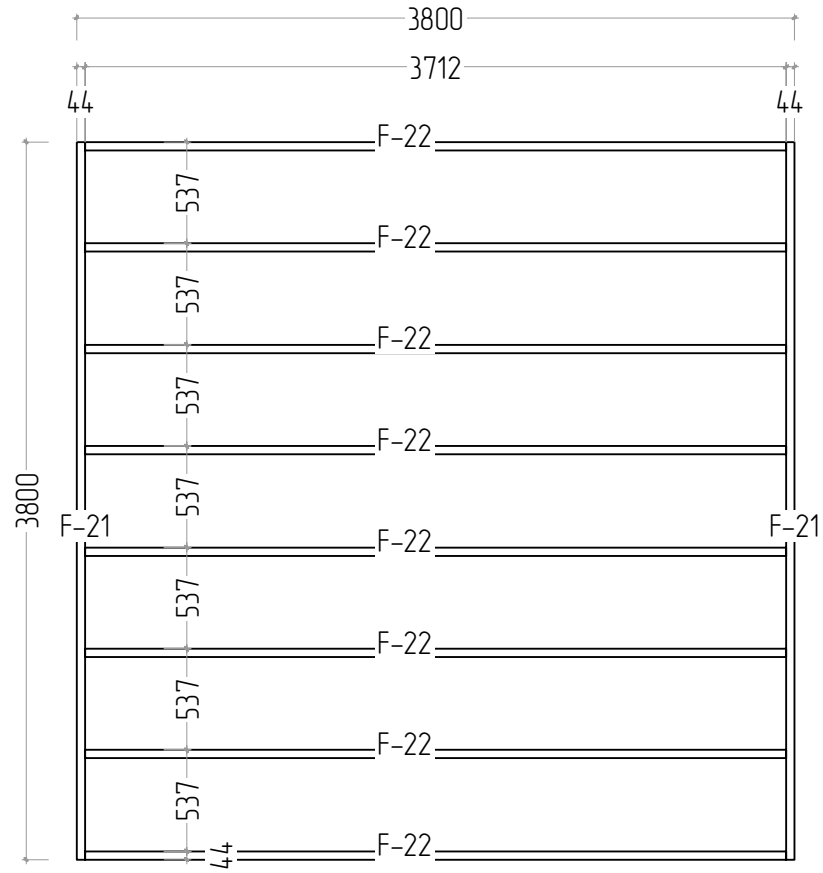

STAGE 2

Paloma 34 4X4

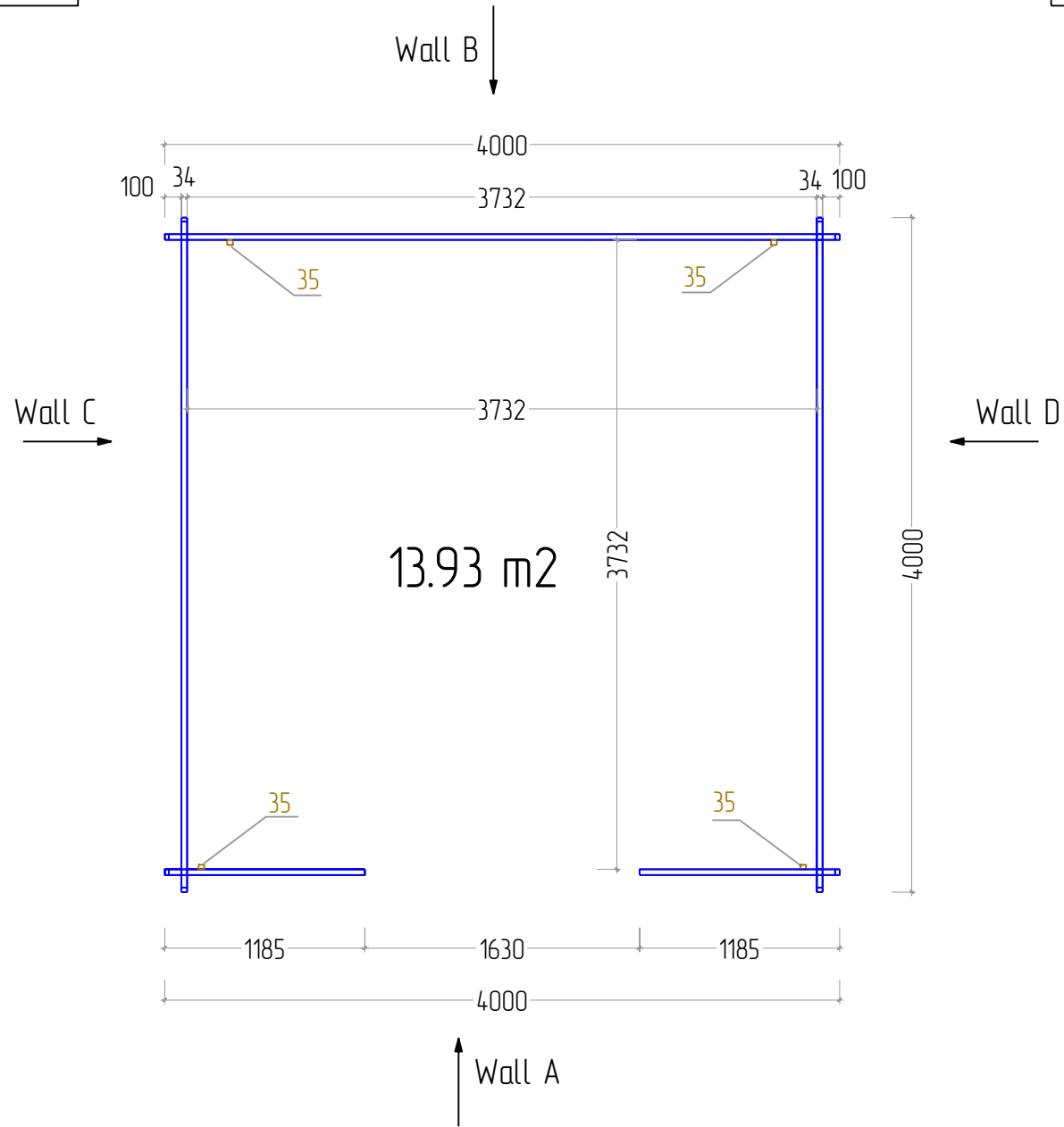

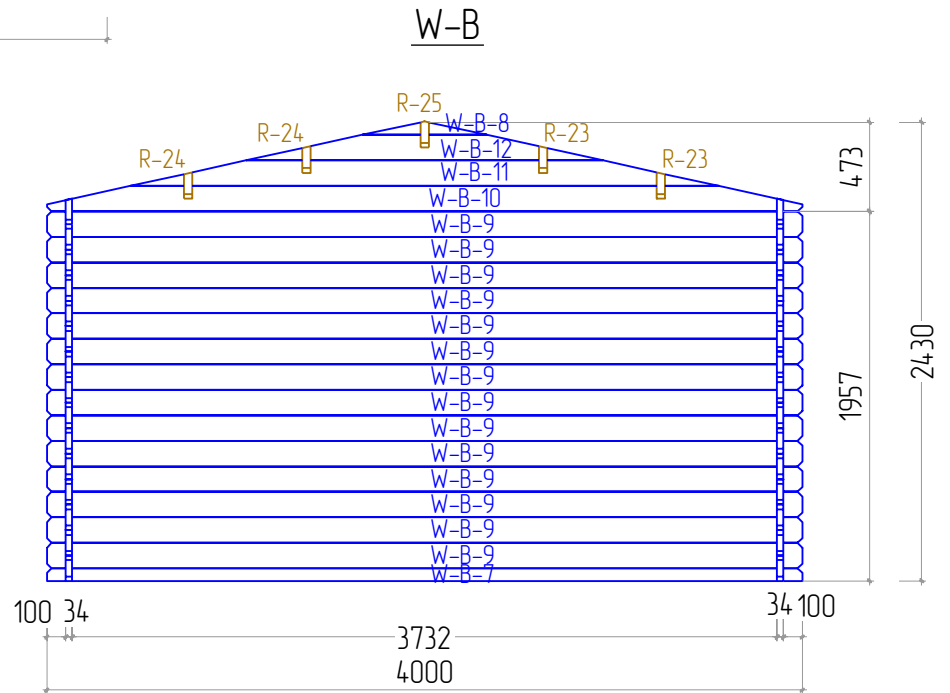
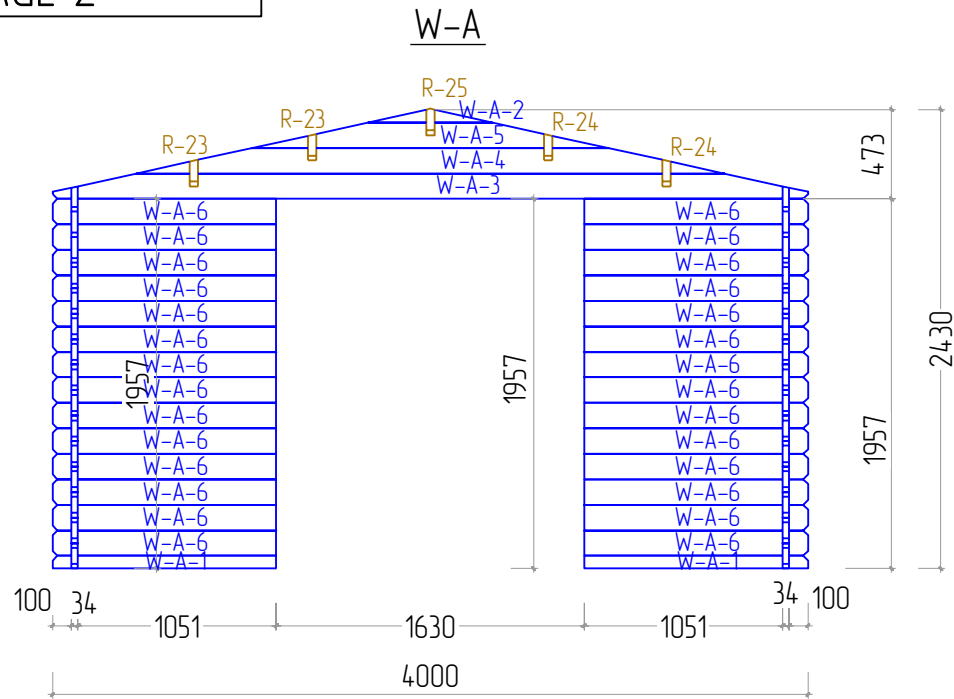

W-C

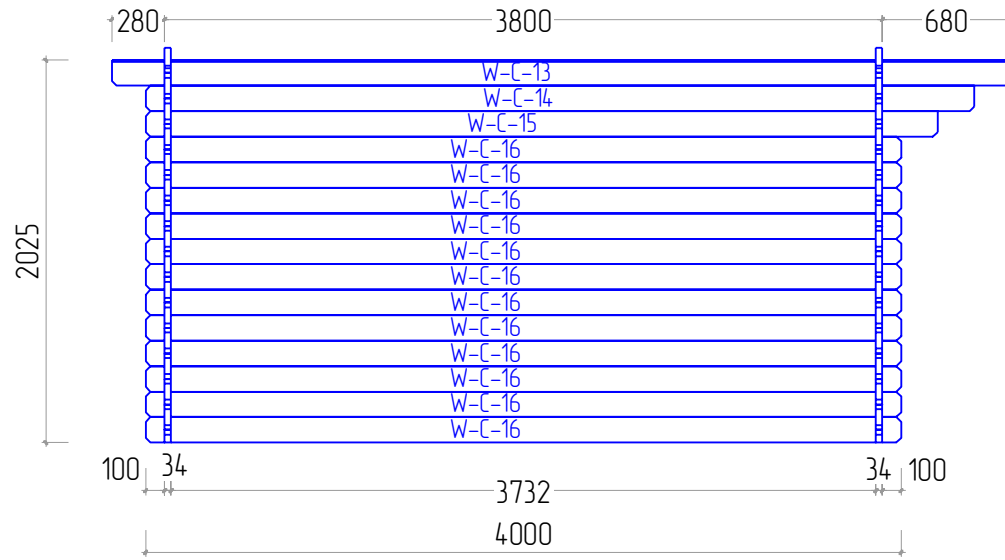

W-D

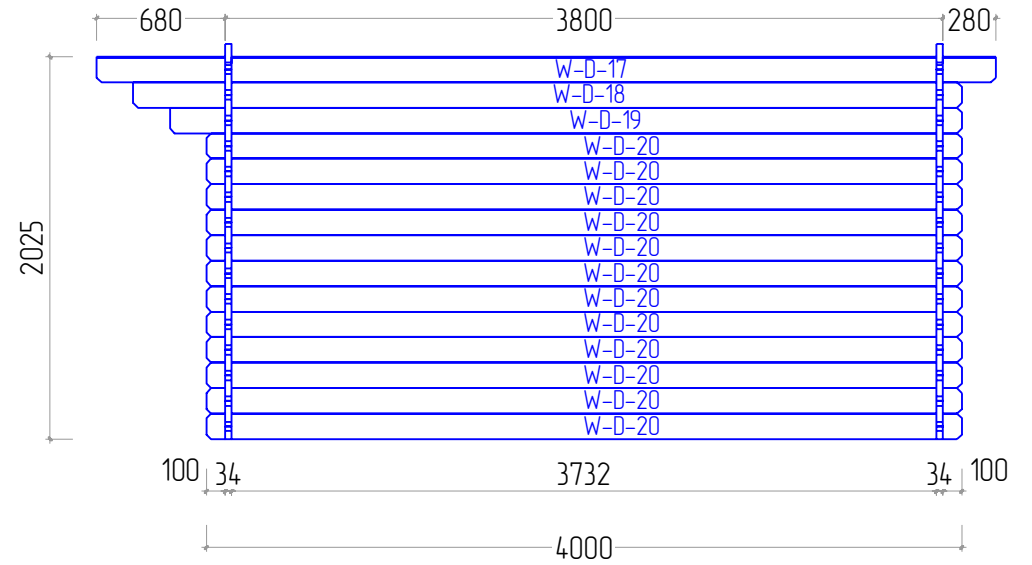

STAGE 3

Paloma 34 4X4

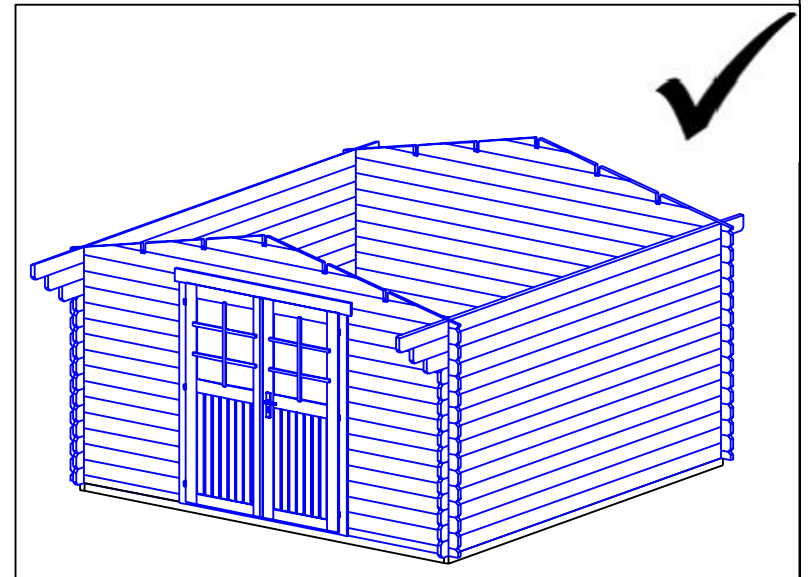
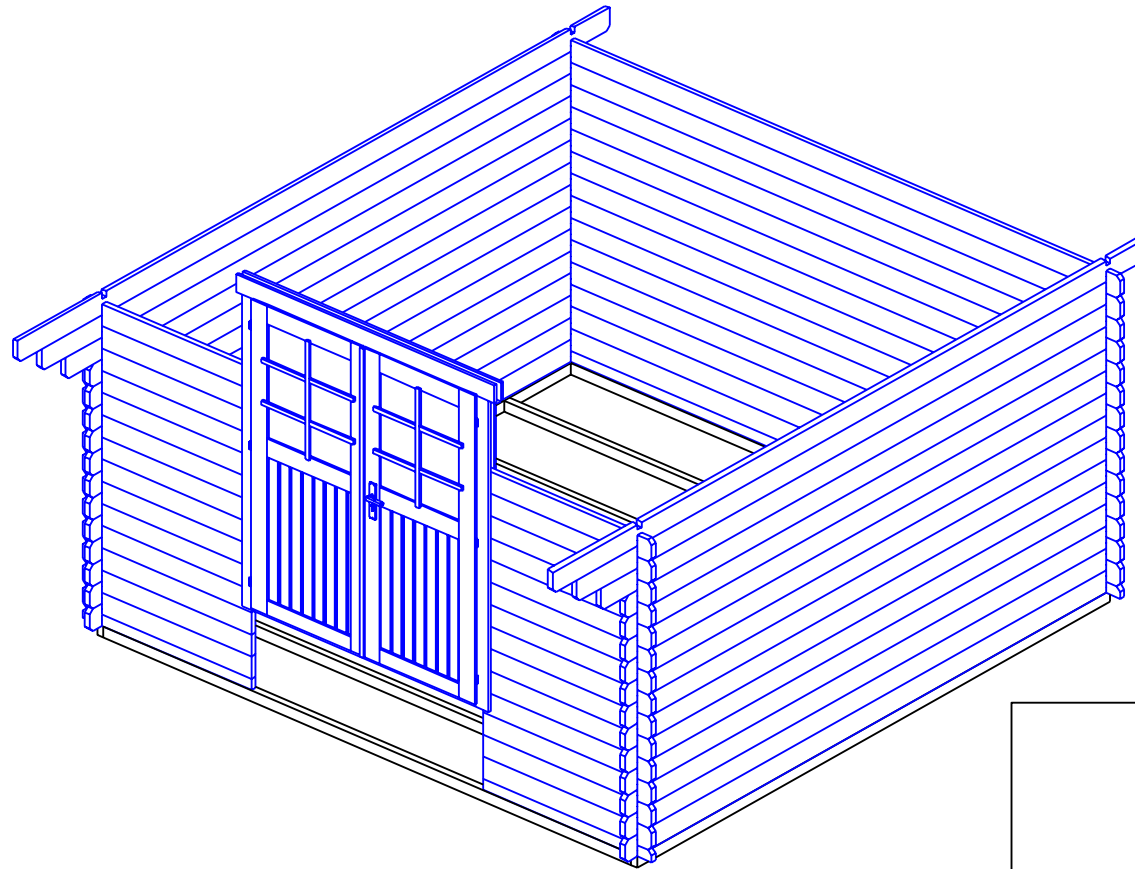

STAGE 4

Paloma 34 4X4

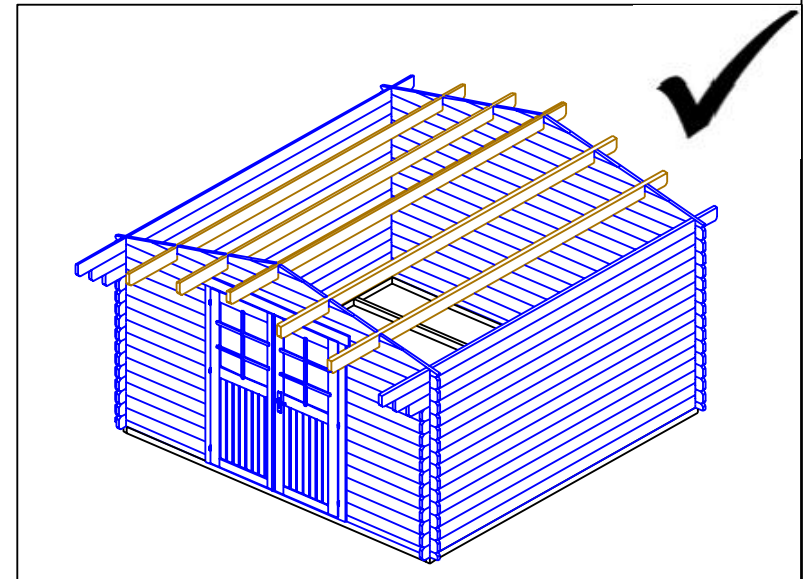
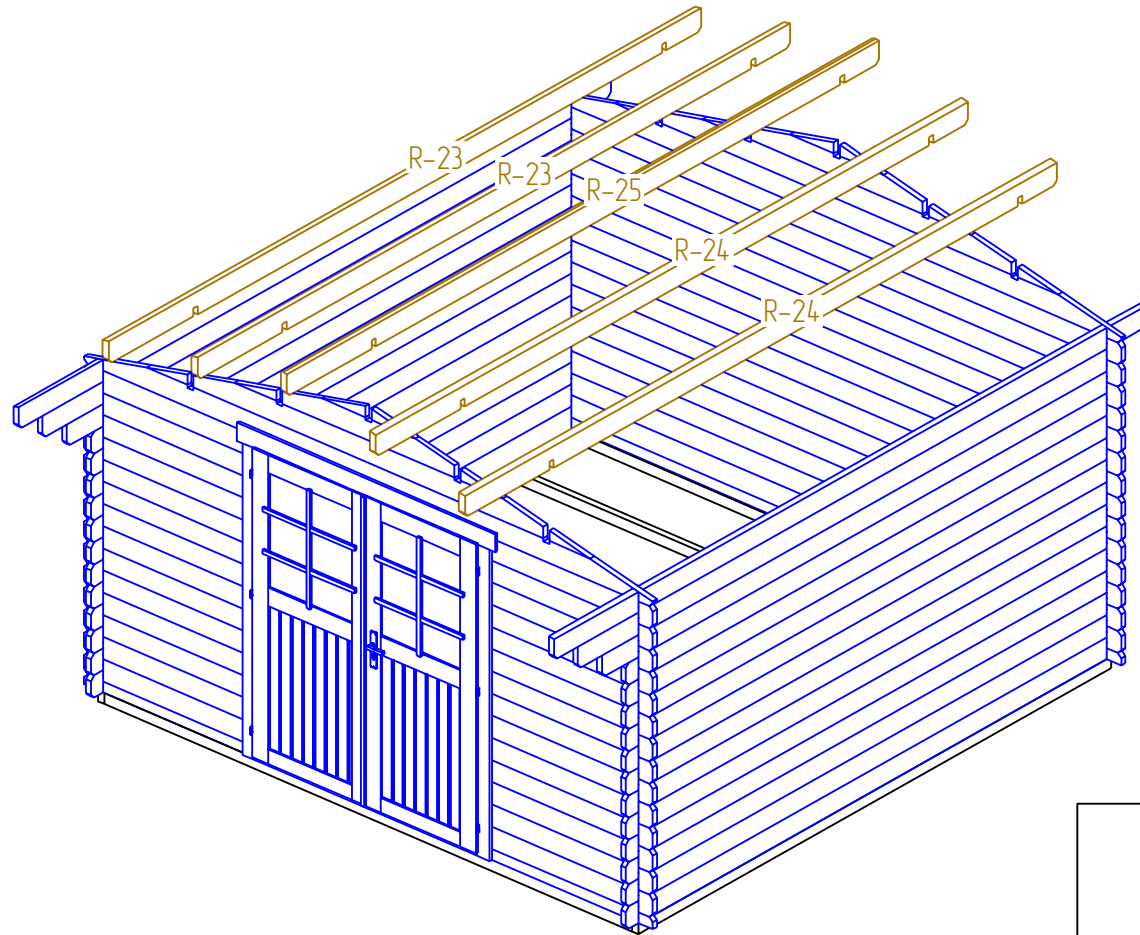



STAGE 5

Paloma 34 4X4

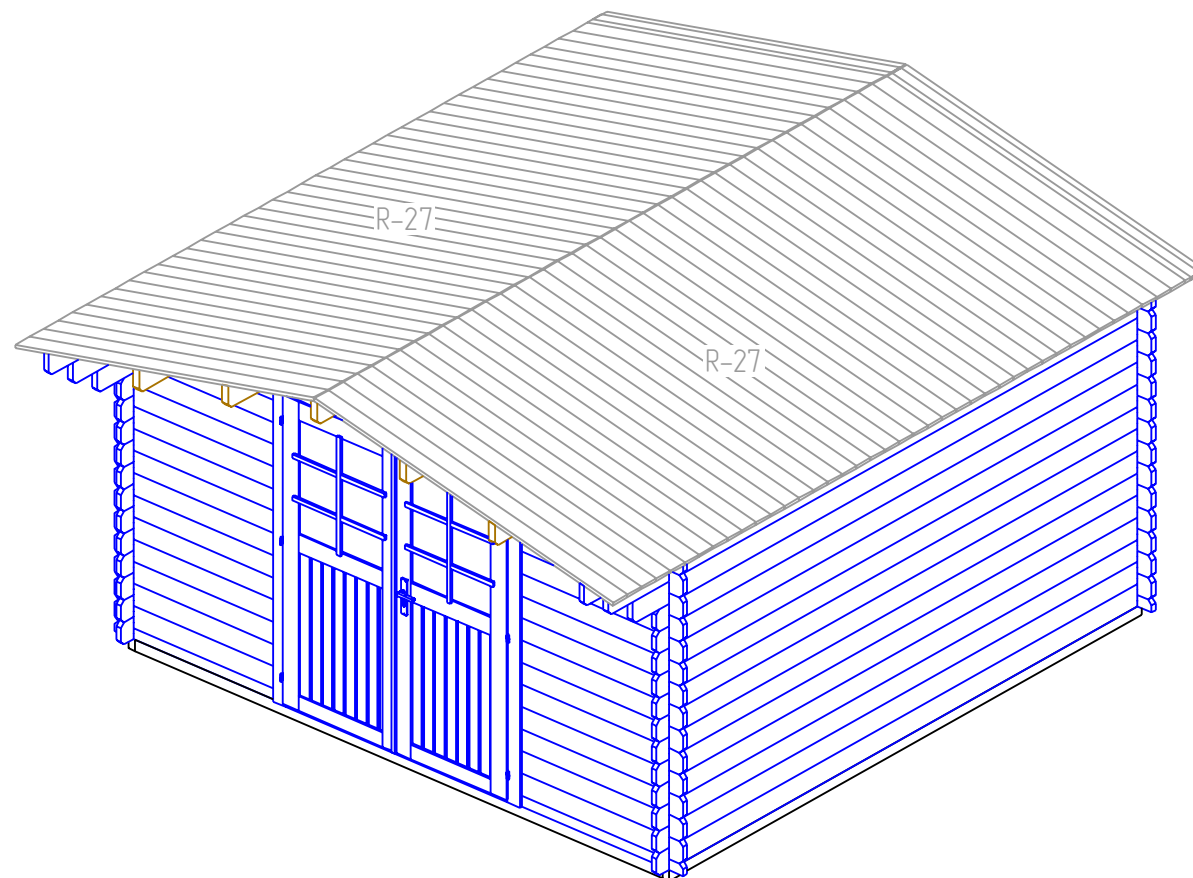

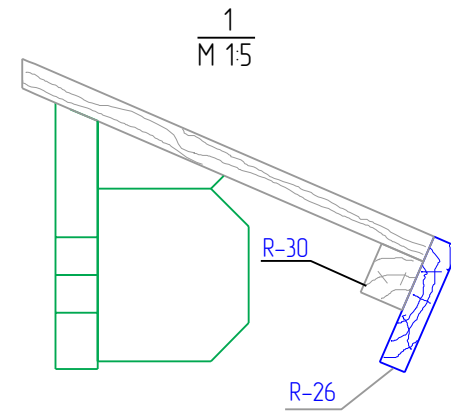
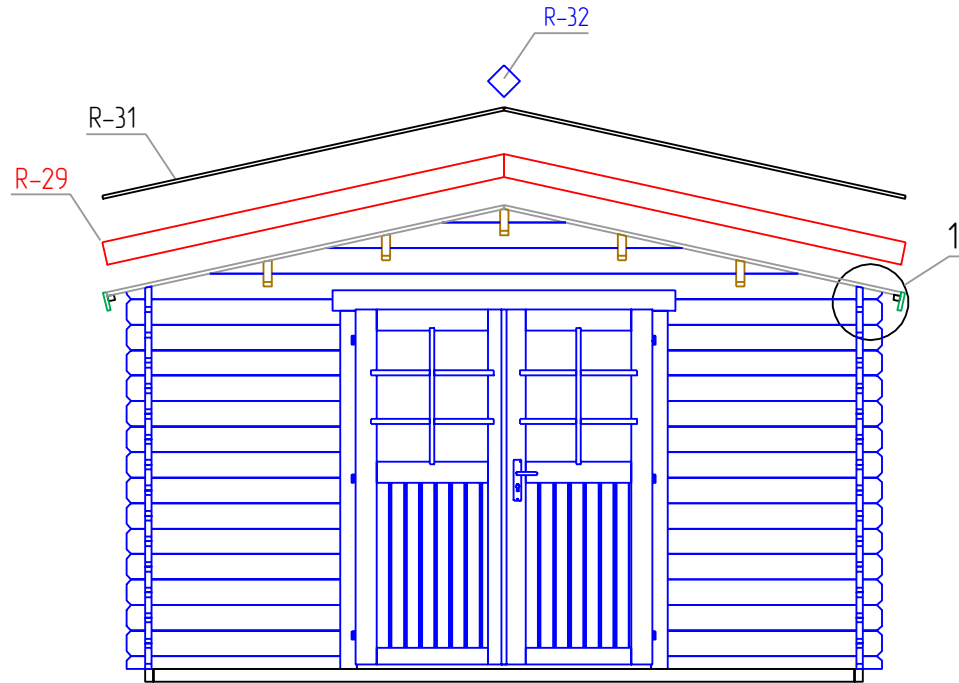

STAGE 6

Paloma 34 4X4

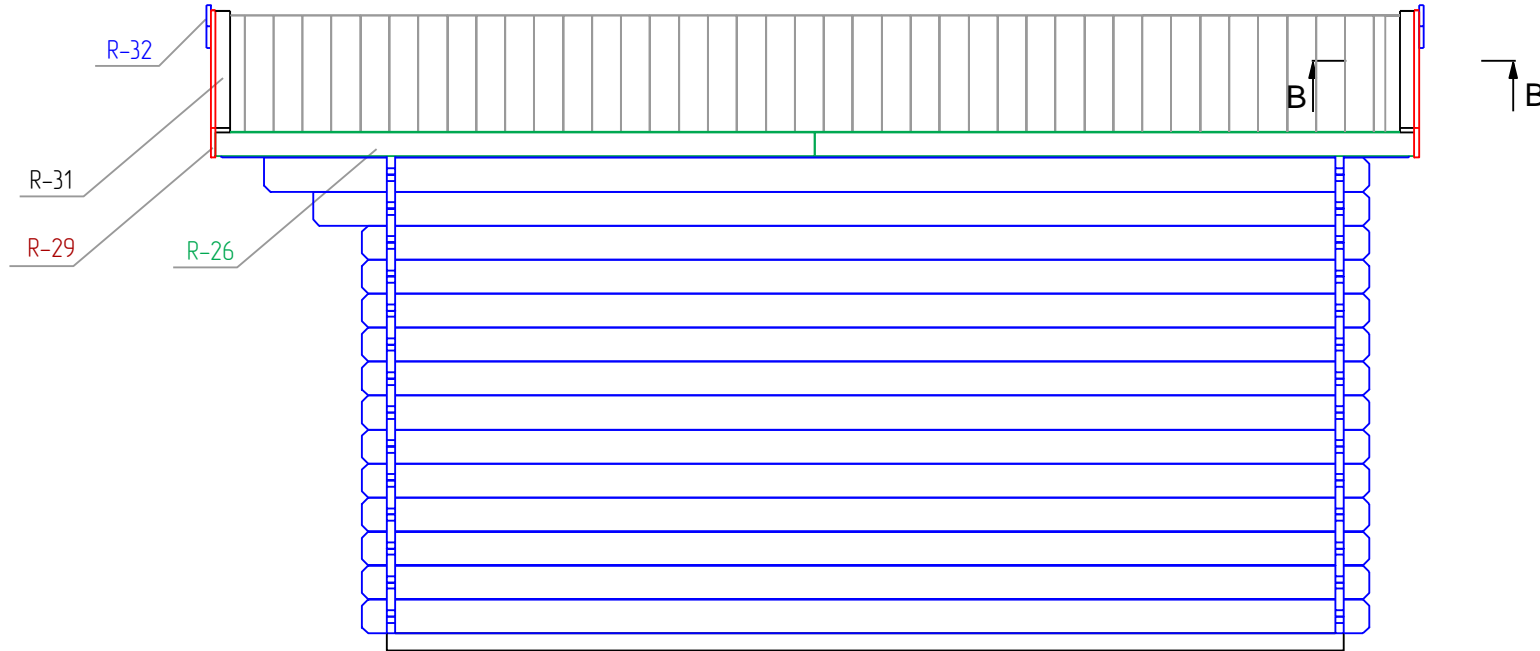

B  
↑

B-B  
M 15

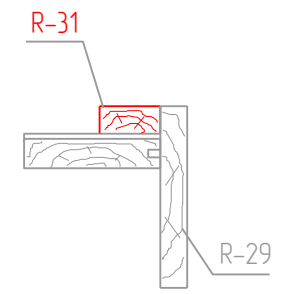

STAGE 7

Paloma 34 4X4

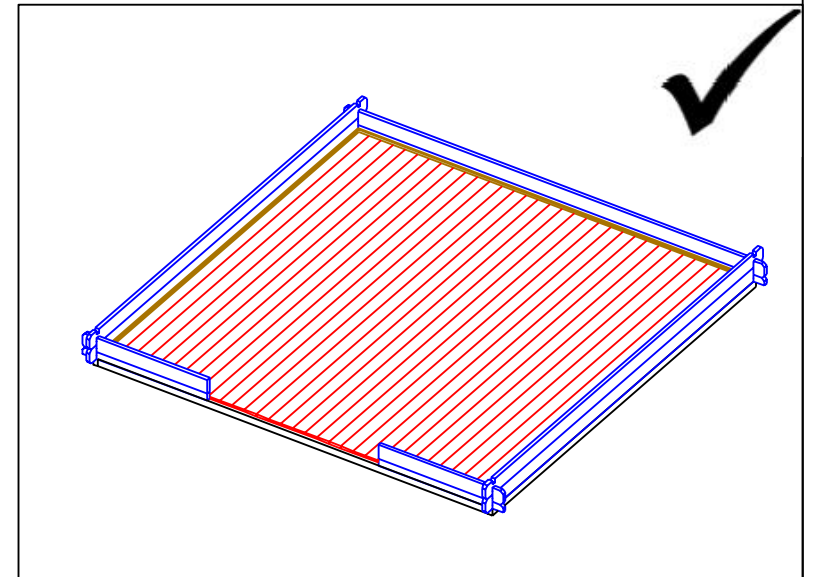
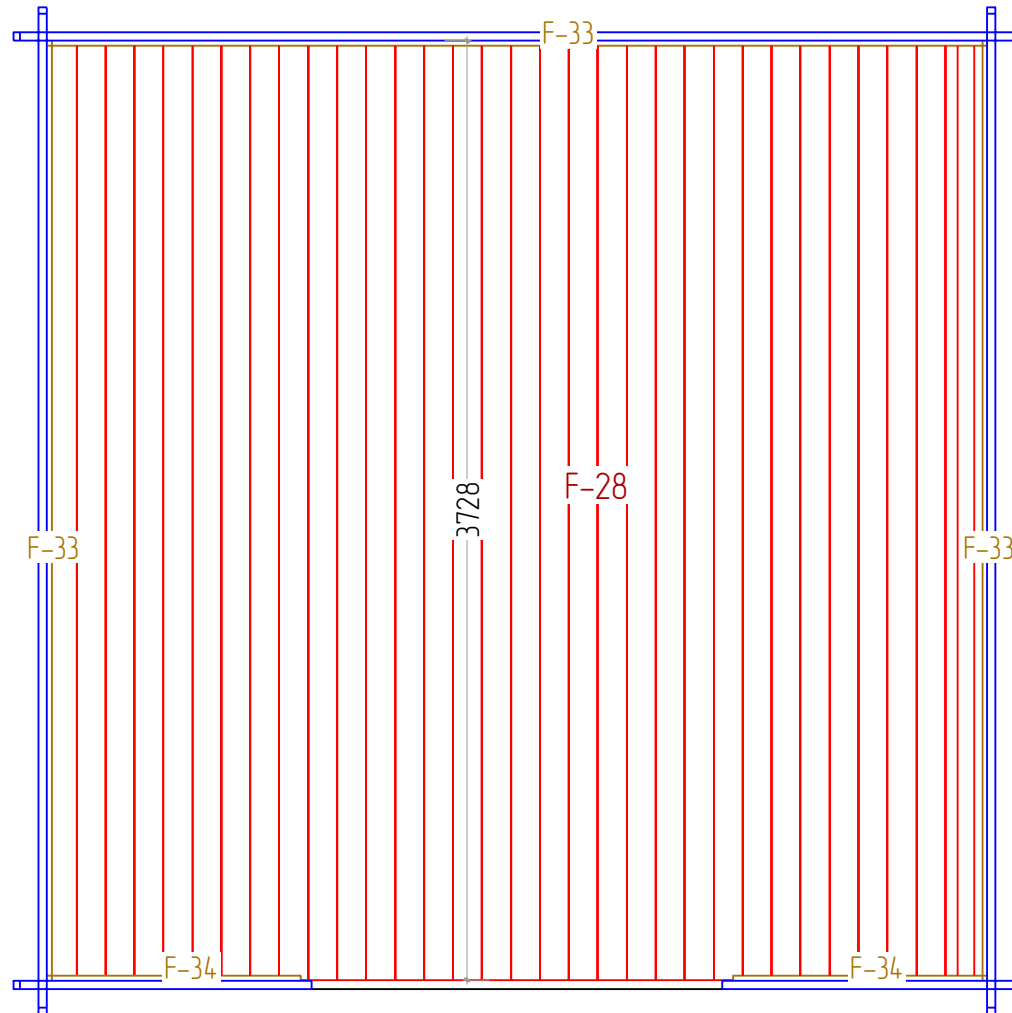

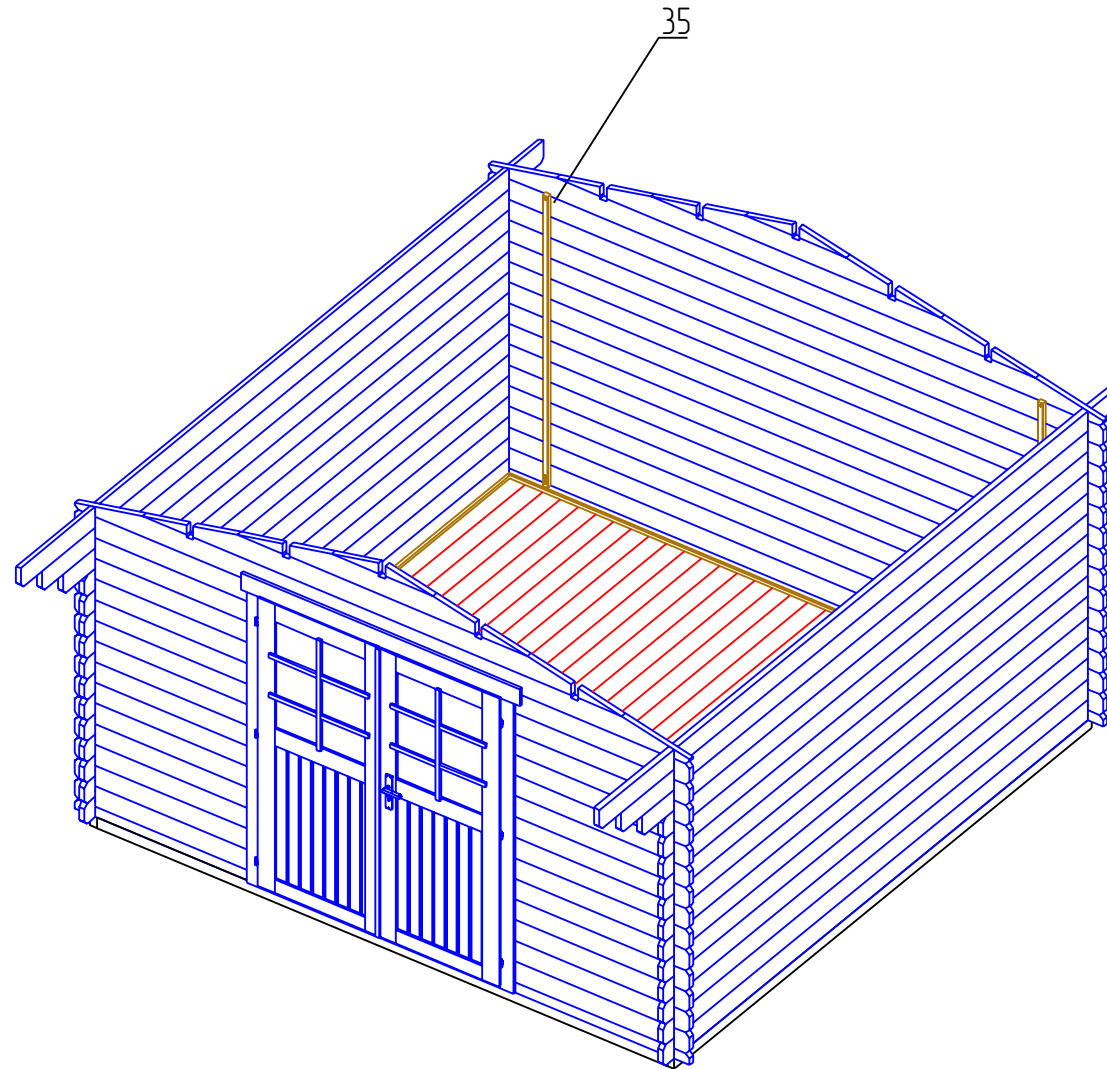

STAGE 1

F  
NR: 21  
PSC: 2  
B/H: 44mm/68mm  
L: 3800mm

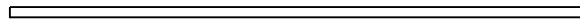

F  
NR: 22  
PSC: 8  
B/H: 44mm/68mm  
L: 3712mm

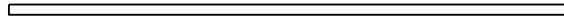

STAGE 2

W  
NR: A 1  
PSC: 2  
B/H: 34mm/68mm  
L: 1185mm

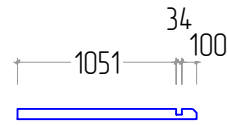

W  
NR: A 6  
PSC: 28  
B/H: 34mm/135mm  
L: 1185mm

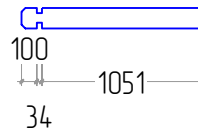

W  
NR: B 7  
PSC: 1  
B/H: 34mm/68mm  
L: 4000mm

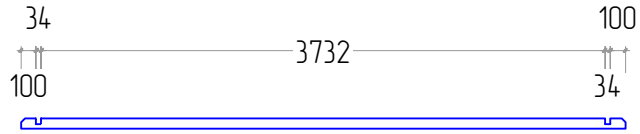

W  
NR: B 9  
PSC: 15  
B/H: 34mm/135mm  
L: 4000mm

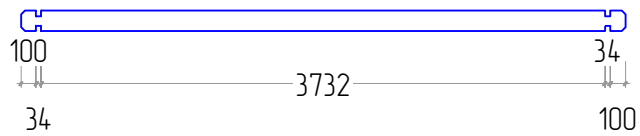

W  
NR: C 13  
PSC: 1  
B/H: 34mm/135mm  
L: 4760mm

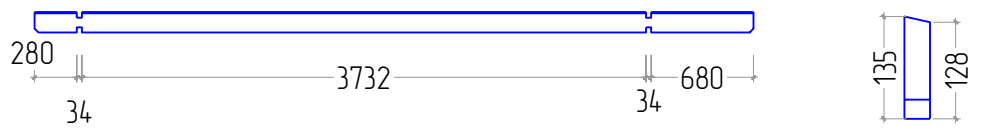

W  
NR: C 14  
PSC: 1  
B/H: 34mm/135mm  
L: 4387mm

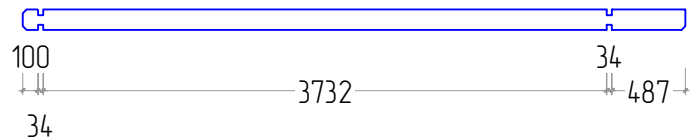

W  
NR: C 15  
PSC: 1  
B/H: 34mm/135mm  
L: 4193mm

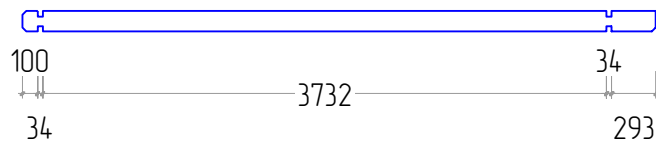

W  
NR: C 16  
PSC: 12  
B/H: 34mm/135mm  
L: 4000mm

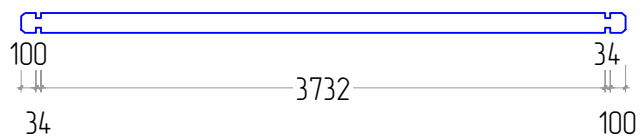

# Paloma 34 4X4

W NR: D 17 PSC: 1 B/H: 34mm/135mm L: 4760mm	
W NR: D 18 PSC: 1 B/H: 34mm/135mm L: 4387mm	
W NR: D 19 PSC: 1 B/H: 34mm/135mm L: 4193mm	
W NR: D 20 PSC: 12 B/H: 34mm/135mm L: 4000mm	
W NR: A PSC: 1	
W NR: B PSC: 1	
<b>STAGE 3</b>	
Door PSC: 1 B/H: 1630mm/1958mm	
<b>STAGE 4</b>	
R NR: 23 PSC: 2 B/H: 44mm/140mm L: 4760mm	
R NR: 25 PSC: 1 B/H: 44mm/140mm L: 4760mm	
R NR: 24 PSC: 2 B/H: 44mm/140mm L: 4760mm	

STAGE 5

R  
 NR: 27  
 PSC: 85  
 B/H: 20mm/115mm  
 L: 2150mm



STAGE 6

R  
 NR: 26  
 PSC: 4  
 B/H: 18mm/95mm  
 L: 2380mm



R  
 NR: 29  
 PSC: 4  
 B/H: 18mm/120mm  
 L: 2178mm

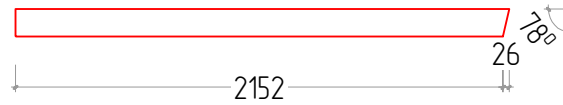

R  
 NR: 30  
 PSC: 4  
 B/H: 28mm/34mm  
 L: 2380mm



R  
 NR: 31  
 PSC: 4  
 B/H: 18mm/58mm  
 L: 2173mm



R  
 NR: 37  
 PSC: 2  
 B/H: 18mm/120mm  
 L: 120mm



STAGE 7

F  
 NR: 28  
 PSC: 34  
 B/H: 20mm/115mm  
 L: 3728mm



F  
 NR: 34  
 PSC: 2  
 B/H: 18mm/20mm  
 L: 1008mm



F  
 NR: 33  
 PSC: 3  
 B/H: 18mm/20mm  
 L: 3732mm





# W-A

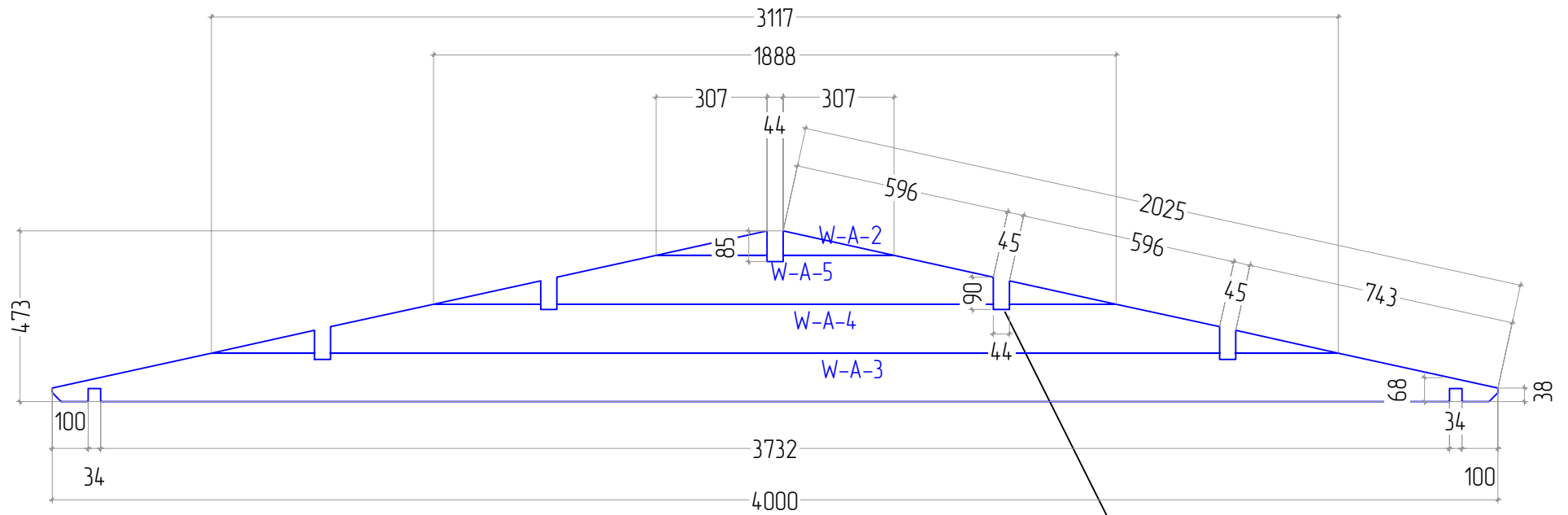

Размеры пазов  
под боковые прогоны идентичны

# W-B

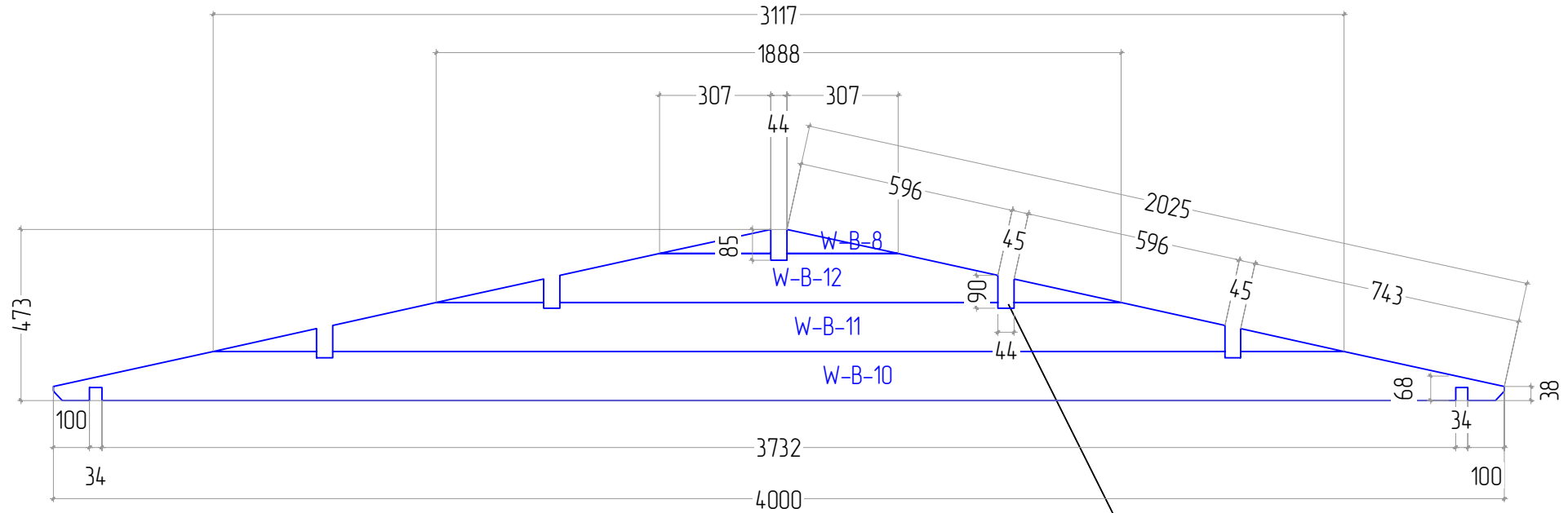

Размеры пазов  
под дощевые прогоны идентичны

Paloma 34 4X4

## STAGE 8

NR: 35  
PSC: 4  
B/H: 28mm/34mm  
L: 1900mm

